

Issue No. : Issue 1  
Issue Date : June 2022  
Project No. : 1825



## **MONTHLY ENVIRONMENTAL MONITORING & AUDIT REPORT (MAY 2022)**

**FOR**

**PORT SHELTER PHASE 3, PO TOI  
O SEWERAGE TREATMENT  
PLANT**

Prepared by

Allied Environmental Consultants Limited

**COMMERCIAL-IN-CONFIDENCE**

**Allied Environmental Consultants Limited**

Member of AEC Group (HKEX Stock Code: 8320.HK)

27/F, Overseas Trust Bank Building, 160 Gloucester Road, Wan Chai, Hong Kong

www.asecg.com T: +852 2815 7028 F: +852 2815 5399

**沛然環境評估工程顧問有限公司**

沛然環保集團成員 (港交所股份代號: 8320.HK)

香港灣仔告士打道 160 號海外信託銀行大廈 27 樓

Our Ref: PL-202205054

Drainage Services Department  
Special Duty Division  
42/F, Revenue Tower, 5 Gloucester Road,  
Wan Chai, Hong Kong.

Attention: Ms. Janet YUEN

11 June 2022

Dear Janet,

**Port Shelter Sewerage, Stage3 - Sewerage Works at Po Toi O  
Monthly EM&A Report for May 2022**

Reference is made to your submission of the Monthly EM&A Report for May 2022 received by email on 7 June 2022 and the subsequent revision on 10 June 2022. We are pleased to inform you that we have no adverse comment on the captioned report.

Thank you for your attention. Please do not hesitate to contact the undersigned should you have any queries.

Yours faithfully,



F.C. Tsang  
Independent Environmental Checker

cc. ETL – Timmy WONG

Issue No. : Issue 1  
Issue Date : June 2022  
Project No. : 1825



## MONTHLY ENVIRONMENTAL MONITORING & AUDIT REPORT (MAY 2022)

FOR

## PORT SHELTER PHASE 3, PO TOI O SEWERAGE TREATMENT PLANT

Prepared by

Allied Environmental Consultants Limited

**COMMERCIAL-IN-CONFIDENCE**

Certified by:

A handwritten signature in black ink, appearing to read 'Timmy Wong', written over a horizontal line.

Timmy WONG  
Environmental Team Leader

Verified by:

A handwritten signature in black ink, appearing to read 'F.C. Tsang', written over a horizontal line.

F.C. TSANG  
Independent Environmental Checker

**Allied Environmental Consultants Limited**

Member of AEC Group (HKEX Stock Code: 8320.HK)

27/F, Overseas Trust Bank Building, 160 Gloucester Road, Wan Chai, Hong Kong

www.asecg.com T: +852 2815 7028 F: +852 2815 5399

**沛然環境評估工程顧問有限公司**



沛然環保集團成員 (港交所股份代號: 8320.HK)

香港灣仔告士打道 160 號海外信託銀行大廈 27 樓

## Document Verification

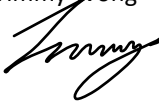
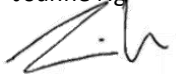

**Project Title** Port Shelter Phase 3, Po Toi O Sewerage Treatment Plant **Project No.** 1825  
**Document Title** Monthly Environmental Monitoring & Audit Report (May 2022)

Issue No.	Issue Date	Description	Prepared by	Checked by	Approved by
1	June 2022	1st Submission	Timmy Wong 	Joanne Ng 	Grace Kwok 

### Allied Environmental Consultants Limited

Member of AEC Group (HKEX Stock Code: 8320.HK)

27/F, Overseas Trust Bank Building, 160 Gloucester Road, Wan Chai, Hong Kong

www.asecg.com T: +852 2815 7028 F: +852 2815 5399

### 沛然環境評估工程顧問有限公司

沛然環保集團成員 (港交所股份代號: 8320.HK)

香港灣仔告士打道 160 號海外信託銀行大廈 27 樓

## Table of Contents

1. Executive Summary.....	1
1.2. Key Construction Works During the Reporting Period .....	1
1.3. Summary of Exceedances, Investigation and Follow-up .....	2
1.4. Complaint Handling, Prosecution and Public Engagement .....	2
1.5. Reporting Change of EM&A Programme.....	2
1.6. Future Key Issues .....	2
2. Introduction .....	3
2.2. Project Background.....	3
2.3. Scope of Report .....	4
2.4. Project Organisation .....	4
2.5. Construction Programme and Activities.....	5
3. Air Quality .....	6
3.1. Monitoring Requirements .....	6
3.2. Monitoring Equipment .....	6
3.3. Monitoring Parameters, Frequency and Duration .....	8
3.4. Monitoring Locations.....	8
3.5. Monitoring Methodology .....	9
3.6. Monitoring Results and Observations .....	12
3.7. Other Influencing Factors of the Monitoring Results.....	13
4. Noise .....	14
4.1. Monitoring Requirements .....	14
4.2. Monitoring Equipment .....	14
4.3. Monitoring Locations.....	15
4.4. Monitoring Parameters and Frequency .....	16
4.5. Monitoring Methodology .....	16
4.6. Monitoring Results and Observations .....	17

4.7. Other Influencing Factors of the Monitoring Results .....	18
5. Water Quality .....	19
5.1. Monitoring Requirements .....	19
5.2. Monitoring Parameters and Frequency .....	20
5.3. Monitoring Locations.....	20
5.4. Results and Observations .....	21
6. Environmental Site Inspection and Audit .....	22
6.1. Site Inspection .....	22
6.2. Waste Management .....	25
6.3. Status of Environmental Licenses, Notification and Permits.....	29
6.4. Implementation Status on Environmental Protection Requirements.....	29
6.5. Summary of Complaints, Notification of Summons, Successful Prosecutions and Public Engagement Activities.....	29
7. Future Key Issues .....	30
7.1. Construction Programme for the Upcoming Reporting Month .....	30
7.2. Reinstatement Works Key Issues for the Upcoming Reporting Month .....	30
7.3. Monitoring Schedule for the Coming Month .....	30
8. Conclusion.....	31
8.1. General .....	31
8.2. Environmental Impact Monitoring .....	31
8.3. Environmental Site Inspections .....	31
8.4. Complaint Log .....	31
8.5. Reporting Changes.....	31
8.6. Notifications of Summons and Successful Prosecutions .....	31

## List of Tables

Table 2-1	Contact Information of Key Personnel.....	4
Table 3-1	Action and Limit Levels for 1-hour TSP .....	6
Table 3-2	Action and Limit Levels for 24-hour TSP .....	6
Table 3-3	Equipment Used for Air Quality Monitoring.....	7
Table 3-4	Monitoring Parameters for Air Quality Monitoring .....	8
Table 3-5	Location of Air Quality Monitoring Stations .....	9
Table 3-6	1-hour Air Quality Monitoring Results in the Reporting Period .....	13
Table 3-7	24-hour Air Quality Monitoring Results in the Reporting Period .....	13
Table 4-1	Action and Limit Levels for Construction Noise .....	14
Table 4-2	Noise Monitoring Equipment.....	15
Table 4-3	Description of Proposed Noise Monitoring Locations .....	15
Table 4-4	Parameters for Noise Impact Monitoring .....	16
Table 4-5	Summary of Construction Noise Monitoring Results in the Reporting Period .....	17
Table 5-1	Parameters of Water Quality Monitoring .....	20
Table 5-2	Summary of Water Quality Impact Monitoring Stations .....	21
Table 6-1	Observations and Recommendations in the Reporting Month.....	22
Table 6-2	IEC Surprise Site inspection Observations and Recommendations in the Reporting Month .	25
Table 6-3	Summary of Waste Flow Table .....	28
Table 6-4	Status of Environmental License, Notification and Permit .....	29

## List of Figures .....

Figure 2-1	Layout Plan of the Captioned Project
Figure 3-1	Proposed Air Quality and Noise Monitoring Stations Locations
Figure 5-1	Locations of Water Quality Impact Monitoring Stations

## List of Appendices

Appendix 2-1	Project Organization Chart
Appendix 2-2	Construction Works Programme
Appendix 3-1	Meteorological Data
Appendix 3-2	Air Quality Monitoring Equipment Calibration Certificates
Appendix 3-3	High-Volume Sampler Calibration Calculation Spreadsheet
Appendix 3-4	Methodology for Correlation Calculation between Potable Laser Dust Meter and High-Volume Sampler
Appendix 3-5	Correlation Calculation between Potable Laser Dust Meter and High-Volume Sampler
Appendix 3-6	Air Quality and Noise Impact Monitoring Schedule
Appendix 3-7	1 hr and 24 hrs TSP Monitoring Result
Appendix 3-8	Event and Action Plan for Air Quality Impact Monitoring
Appendix 4-1	Noise Monitoring Equipment Calibration Certificates
Appendix 4-2	Noise Impact Monitoring Results
Appendix 4-3	Event and Action Plan for Noise Impact Monitoring
Appendix 6-1	Monthly Summary of Waste Flow
Appendix 6-2	Implementation Schedule of Recommended Mitigation Measures
Appendix 6-3	Recommended Mitigation Measures and Proactive Environmental Protection Proforma
Appendix 6-4	Cumulative Statistics on Complaints, Notifications of Summons



## 1. Executive Summary

1.1.1. The proposed sewerage works in Po Toi O (hereafter as “the Project”) is an environmental enhancement project that aims to improve environmental hygiene of the Po Toi O area. The Environmental Impact Assessment (EIA) Report for the Project (Register No: AEIAR-206/2017) was approved on 27 January 2017. The Environmental Permit (EP) (Permit No.: EP-516/2016) was issued on 27 January 2017 and is the current permit for the Project.

1.1.2. Allied Environmental Consultants (AEC) has been appointed by Drainage Services Department (DSD) as the Environmental Team (ET) to undertake the EM&A programme during construction phase of the Project in accordance to the approved EM&A Manual for the Project.

1.1.3. This is the 15<sup>th</sup> monthly Environmental Monitoring & Audit (EM&A) Report prepared by Allied Environmental Consultants Limited (AEC) for the Project. This report summarized the monitoring results and audits findings of the EM&A programme under the EP and the EM&A Manual of the Project during the reporting period of 1 May 2022 to 31 May 2022.

### 1.2. Key Construction Works During the Reporting Period

1.2.1. The main works undertaken during the reporting period are as follows:

-Major activities in the reporting month:

- a) Construction of village sewer;
- b) Slope works.

### **1.3. Summary of Exceedances, Investigation and Follow-up**

1.3.1. There was no action or limit level exceedance record of construction noise and air quality was recorded in the reporting month.

### **1.4. Complaint Handling, Prosecution and Public Engagement**

1.4.1. No complaints, notification of summons and successful prosecution was received in the reporting period. No public engagement activity was conducted in the reporting month.

1.4.2. No notification of summons and successful prosecution was received in the reporting period. No public engagement activity was conducted in the reporting month.

1.4.3. No air quality, noise and water complaints during 0700 – 1900 hours on normal weekdays was received in the reporting month.

### **1.5. Reporting Change of EM&A Programme**

1.5.1. No reporting change of the EM&A programme in this reporting month.

### **1.6. Future Key Issues**

1.6.1. The main works will be anticipated in the next reporting period are as follows:

-Major activities in the upcoming month:

- a) Construction of village sewer;
- b) Slope works.
- c) Construction of temporary working platform and installation of silt curtain for HDD.

## 2. Introduction

### 2.1. Project Info

2.1.1. Allied Environmental Consultants (AEC) has been appointed by Drainage Services Department (DSD) as the Environmental Team (ET) to undertake the EM&A programme during construction phase of the Project in accordance to the approved EM&A Manual for the proposed sewerage works in Po Toi O (hereafter as “The Project”), an environmental enhancement project that aims to improve environmental hygiene of the Po Toi O area.

### 2.2. Project Background

2.2.1. Po Toi O is located in the southern part of Sai Kung District, next to Clear Water Bay. There is a small settlement called Po Toi O village around the bay. There is currently no public sewerage system for the village. Sewage and wastewater generated by local residents and local restaurants are treated by septic tanks/ soakaway system (STS).

2.2.2. Sewage works at Po Toi O comprise sewage collection, treatment and disposal facilities at Po Toi O under Port Shelter Sewerage, Stage 3 – Sewerage Works at Po Toi O.

2.2.3. The Project in Po Toi O mainly comprises of the following items:

- i. Provision of village sewerage to the unsewered areas of Po Toi O. The works involve construction of about 800m of gravity sewers and 400m of rising mains;
- ii. Construction of a local sewage treatment plant (STP) with Average Dry Weather Flow (ADWF) of about 139m<sup>3</sup>/day; and
- iii. Construction of a submarine outfall of about 385m in length.

2.2.4. The Project consists of the following works, which are classified as Designated Projects under Part I, Schedule 2 of the Environmental Impact Assessment Ordinance (EIAO):

- i. Item Q.1 – A sewage treatment plant and portion of sewer alignments in a conservation area;
- ii. Item C.12 (a) (v) and (vii) – A dredging operation which is less than 500m from the nearest boundary of an existing fish culture zone and coastal protection area; and
- iii. Item F.6 – A submarine sewage outfall.

2.2.5. The Environmental Impact Assessment (EIA) Report “Port Shelter Sewerage, Stage 3 – Sewerage Works at Po Toi O” (Register No: AEIAR-206/2017) was approved on 27 January 2017. A Environmental Permit (EP) (Permit No.: EP-516/2016) was issued on 27 January 2017 and is the current permit for the Project.

2.2.6. The EM&A programme of the Project shall be implemented in accordance with the requirements and procedures set out in the EM&A Manual and the Environmental Permit (EP) of the Project (Permit No.: EP-516/2016).

2.2.7. The air quality and noise baseline monitoring works were conducted from 23 December 2020 to 5 January 2021 and the water quality baseline monitoring work was conducted from 17 December 2020 to 12 January 2021. A Baseline Monitoring Report had been submitted to EPD on 10 February 2021.

### 2.3. Scope of Report

2.3.1. This is the 15<sup>th</sup> EM&A Report prepared by AEC for the Port Shelter Sewerage, Stage 3 – Sewerage Works at Po Toi O. This report summarized the monitoring results and audits findings of the EM&A programme under the EP of the Project and in accordance with the EM&A Manual during the reporting period of 1 May 2022 to 31 May 2022.

### 2.4. Project Organisation

2.4.1. The project organization structure is shown in **Appendix 2-1**. The key personnel contact names and numbers are summarized in **Table 2-1**.

**Table 2-1 Contact Information of Key Personnel**

Position	Party	Name	Telephone
Project Proponent	Drainage Services Department (DSD)	Ms. Yuen Ho Yan	2594 7353
Resident Engineer (RE)	Binnies Hong Kong Limited (Binnies)	Mr. Eugene Chan	6392 3809
Independent Environmental Checker (IEC)	Acuity Sustainability Consulting Limited (ASC)	Dr. F.C. Tsang	2698 8060
Environmental Team (ET)	Allied Environmental Consultants Limited (AEC)	Mr. Timmy Wong	3915 7186
Environmental Officer (EO)	China Geo-engineering Corporation (CGC)	Mr. Jasper Tang	6997 5530

## **2.5. Construction Programme and Activities**

2.5.1. The main works will be anticipated in the reporting period are as follows:

Major activities in the reporting month:

- a) Construction of village sewer;
- b) Slope works.

2.5.2. The Construction Programme is shown in **Appendix 2-2**. The general layout plan of the Project is shown in **Figure 2-1**.

### 3. Air Quality

#### 3.1. Monitoring Requirements

3.1.1. In accordance with the EM&A Manual, impact air quality monitoring shall be carried out throughout the construction period at all approved air quality monitoring locations (AMSs). 24-hours total suspended particles (TSP) monitoring shall be conducted at least once every 6 days. Meanwhile, 1-hour TSP monitoring shall be conducted at least 3 times every 6 days when the highest dust impact takes place. The Action and Limit levels for 1-hour and 24-hours TSP level are provided in **Table 3-1 and Table 3-2**.

**Table 3-1 Action and Limit Levels for 1-hour TSP**

Parameter	Air Quality Monitoring Station (AMSs)	Action Level ( $\mu\text{g}/\text{m}^3$ )	Limit Level ( $\mu\text{g}/\text{m}^3$ )
1-hr TSP ( $\mu\text{g}/\text{m}^3$ )	AMS1N	319	500 $\mu\text{g}/\text{m}^3$
	AMS2N1	279	
	AMS3N	303	
	AMS4N	278	

**Table 3-2 Action and Limit Levels for 24-hour TSP**

Parameter	Air Quality Monitoring Station (AMSs)	Action Level ( $\mu\text{g}/\text{m}^3$ )	Limit Level ( $\mu\text{g}/\text{m}^3$ )
24-hr TSP ( $\mu\text{g}/\text{m}^3$ )	AMS1N	153	260 $\mu\text{g}/\text{m}^3$
	AMS2N1	179	
	AMS3N	158	
	AMS4N	144	

#### 3.2. Monitoring Equipment

3.2.1. The 24-hour TSP air quality monitoring was performed using High Volume Air Samplers (HVS) at each of the designated monitoring stations. The HVS are calibrated by a HVS calibrator. Meanwhile 1-hour TSP air quality monitoring was performed using portable TSP monitors. The equipment used for air quality monitoring are given in **Table 3-3**.

**Table 3-3 Equipment Used for Air Quality Monitoring.**

Air Quality Monitoring	Brand and Model of Equipment	Serial Number
24-hour TSP*	Graseby GMW High Volume Sampler	1180
		1174
		9795
		2483
	Tisch TE-5025A High Volume Sampler Calibrator	3863
1-hour TSP	Sibata LD-3B Portable TSP Monitors	014746
		155331
		597340
		597227

Note:

*\* If 24-hour TSP monitoring is significantly affected by power supply inconsistency at Po Toi O village, 24-hour TSP monitoring will be conducted by direct reading dust meter instead. The proposal for the use of direct reading dust meters for 24-hour TSP monitoring was approved by IEC and ER of the Project.*

3.2.2. Meteorological information (such as the humidity, rainfall, air pressure and temperature etc.) were collected from Hong Kong Observatory (HKO)'s Weather Stations.

3.2.3. According to the approved EM&A Manual, wind data monitoring equipment shall be provided and setup for logging wind speed and wind direction near the dust monitoring locations. The equipment installation location shall be proposed by the ET and agreed with the IEC. For installation and operation of wind data monitoring equipment, the following points shall be observed:

- a) The wind sensors should be installed 10 m above ground so that they are clear of obstructions or turbulence caused by buildings.
- b) The wind data should be captured by a data logger. The data shall be downloaded for analysis at least once a month.
- c) The wind data monitoring equipment should be re-calibrated at least once every six months.
- d) Wind direction should be divided into 16 sectors of 22.5 degrees each.

3.2.4. It is noted that after liaison with the Po Toi O resident's representative on 22 December 2020, the resident's representative has rejected the access to the space and power supply for ET to install the wind data monitoring stations. Therefore, ET had proposed the alternative method for wind data collection according to section 3.4.7 of EM&A Manual.

3.2.5. The alternative method for wind data collection was adopted the wind data information collected from the HKO's Waglan Island weather station as the representative wind data. Although there are other closer weather stations, Waglan Island Station was selected as it is the nearest weather station that measures wind data information mentioned above.

3.2.6. The meteorological data from HKO's Weather Station is given in **Appendix 3-1**.

### 3.3. Monitoring Parameters, Frequency and Duration

3.3.1. The parameters, duration and frequency for air quality impact monitoring is given in **Table 3-4**.

**Table 3-4 Monitoring Parameters for Air Quality Monitoring**

Identification No.	Location	Parameters	Frequency
AMS1N*	Footpath above House No. 28 Po Toi O Chuen Road	1-hr TSP 24-hr TSP	<u>1-hour TSP:</u> At least 3
AMS2N1*	Open space Approx. 15 m from Hung Shing Temple		times for 1-
AMS3N*	Vacant land near Temporary Structure (House) Rocky Shore		hour with
AMS4N*	Resting shelter near Seacrest Villas		every 6 days <u>24-hour TSP:</u> Once every 6 days

Notes:

\*- Due to a number of limitations identified at the air quality monitoring stations in the Approved EM&A Manual for the Project, the monitoring location AMS1 – AMS4 were replaced by alternative monitoring location AMS1N – AMS4N, which were approved by ER and IEC.

### 3.4. Monitoring Locations

3.4.1. Monitoring stations AMS1N, AMS2N1, AMS3N and AMS4N were set up in accordance to the requirements for placement of equipment, as set out in section 3.5.3 of the EM&A manual of the Project. The location of the new representative AMSs and air quality monitoring equipment used are given in **Table 3-5**. Locations of the alternative AMSs are given in **Figure 3-1**.



**Table 3-5 Location of Air Quality Monitoring Stations**

Identification No.	Location	Type of Monitoring	Duration
AMS1N*	Footpath above House No. 28 Po Toi O Chuen Road	TSP	1 hr & 24 hrs
AMS2N1*	Open space approximately 15 m from Hung Shing Temple	TSP	1 hr & 24 hrs
AMS3N*	Vacant land near Temporary Structure (House) Rocky Shore	TSP	1 hr & 24 hrs
AMS4N*	Resting shelter near Seacrest Villas	TSP	1 hr & 24 hrs

Notes:

\*- Due to a number of limitations identified at the air quality monitoring stations in the Approved EM&A Manual for the Project, the monitoring location AMS1 – AMS4 were replaced by alternative monitoring location AMS1N – AMS4N, which were agreed by ER and IEC.

### 3.5. Monitoring Methodology

### 3.6. Monitoring Methodology for 24-hour TSP Monitoring

3.6.1. The HVS was installed in the vicinity of the air quality monitoring stations. The following criteria were considered in the installation of the HVS:

- i. A horizontal platform with appropriate support to secure the sampler against gusty wind was provided.
- ii. The distance between the HVS and any obstacles, such as buildings, was at least twice the height that the obstacle protrudes above the HVS.
- iii. A minimum of 2 meters separation from walls, parapets and penthouse for rooftop sampler.
- iv. A minimum of 2 meters separation from any supporting structure, measured horizontally.
- v. No furnace or incinerator flues nearby.
- vi. Airflow around the sampler was unrestricted.
- vii. Permission was obtained to set up the samplers and access to the monitoring stations.
- viii. A secured supply of electricity was obtained to operate the samplers.
- ix. The sampler was located more than 20 meters from any dripline.
- x. Any wire fence and gate, required to protect the sampler, did not obstruct the monitoring process.
- xi. Flow control accuracy was kept within  $\pm 2.5\%$  deviation over 24-hour sampling period.

3.6.2. The following procedures to be followed for the preparation of filter papers of the HVS:

- i. Glass fibre filters, G810 were labelled and sufficient filters that were clean and without pinholes were selected.
- ii. All filters were equilibrated in the conditioning environment for 24 hours before weighing. The conditioning environment temperature was around 25 °C and not variable by more than  $\pm 3$  °C; the relative humidity (RH) was < 50% and not variable by more than  $\pm 5$ %. A convenient working RH was 40%.
- iii. All filter papers were prepared and analysed by a HOKLAS accredited laboratory and has comprehensive quality assurance and quality control programmes.

3.6.3. The following procedures are followed throughout air quality monitoring works:

- i. The power supply was checked to ensure the HVS works properly.
- ii. The filter holder and the area surrounding the filter were cleaned.
- iii. The filter holder was removed by loosening the four bolts and a new filter, with stamped number upward, on a supporting screen was aligned carefully.
- iv. The filter was properly aligned on the screen so that the gasket formed an airtight seal on the outer edges of the filter.
- v. The swing bolts were fastened to hold the filter holder down to the frame. The pressure applied was sufficient to avoid air leakage at the edges.
- vi. Then the shelter lid was closed and was secured with the aluminium strip.
- vii. The HVS was warmed-up for about 5 minutes to establish run-temperature conditions.
- viii. A new flow rate record sheet was set into the flow recorder.
- ix. On site temperature and atmospheric pressure readings were taken and the flow rate of the HVS was checked and adjusted at around 1.1 m<sup>3</sup> /min, and complied with the range specified in the updated EM&A Manual (i.e., 0.6-1.7 m<sup>3</sup> /min).
- x. The programmable digital timer was set for a sampling period of 24 hrs, and the starting time, weather condition and the filter number were recorded.
- xi. The initial elapsed time was recorded.
- xii. At the end of sampling, on site temperature and atmospheric pressure readings were taken and the final flow rate of the HVS was checked and recorded.
- xiii. The final elapsed time was recorded.
- xiv. The sampled filter was removed carefully and folded in half-length so that only surfaces with collected particulate matter were in contact.

- xv. It was then placed in a clean plastic envelope and sealed.
- xvi. All monitoring information was recorded on a standard data sheet.

3.6.4. The following procedures are followed for the maintenance and calibration of HVS:

- i. The HVS and its accessories were maintained in good working condition, such as replacing motor brushes routinely and checking electrical wiring to ensure a continuous power supply.
- ii. 5-point calibration of the HVS was conducted using TE-5025A Calibration Kit prior to the commencement of monitoring. Bi-monthly 5-point calibration of the HVS will be carried out during impact monitoring. The details for HVS calibration against the TE-5025A Calibration Kit is given in **Appendix 3-3**.

### **3.7. Monitoring Methodology for 24-hour TSP Monitoring by Direct Reading Dust Meters**

3.7.1. Since power supply for HVS for 24-hour TSP monitoring at alternative monitoring locations (i.e., AMS1N to AMS4N) were rejected, the use of direct reading dust meters is adopted to measure both 1-hour and 24-hour average TSP levels for the reporting month.

3.7.2. In accordance to Condition 3.1 of the Project's EP and Section 3.3 of the Project's EM&A Manual, the proposal for alternative monitoring equipment (i.e., direct reading dust meter) for TSP monitoring was approved by IEC and ER.

3.7.3. The measuring procedures of the direct reading dust meters are given in **Section 3.5.10**.

3.7.4. 24 consecutive 1-hour TSP concentration measurement results is adopted for the evaluation of 24-hour TSP concentration. Results are manually logged daily, during daily maintenance of the dust meter. Calculation of the value of 24-hour TSP concentration is given by the average of 24 calculated 1-hour TSP concentration, where the calculated 1-hr TSP concentration is given by the product of the direct reading and the K-factor based on the correlation results between the direct reading meter and HVS. Details for the correlation methodology and correlation record are given in **Appendix 3-4** and **Appendix 3-5**.

3.7.5. HVS for 24-hr TSP monitoring will be adopted once secured supply of electricity becomes available for any agreed TSP monitoring locations.

### **3.8. Monitoring Methodology for 1-Hour TSP Monitoring**

3.8.1. The measuring procedures of the direct reading dust meters were in accordance with the Manufacturer's Instruction Manual as follows:

- i. Turn the power on.
- ii. Close the air collecting opening cover.
- iii. Push the "TIME SETTING" switch to [BG].
- iv. Push "START/STOP" switch to perform background measurement for 6 seconds.
- v. Turn the knob at SENSI ADJ position to insert the light scattering plate.
- vi. Leave the equipment for 1 minute upon "SPAN CHECK" is indicated in the display.
- vii. Push "START/STOP" switch to perform automatic sensitivity adjustment. This measurement takes 1 minute.
- viii. Pull out the knob and return it to MEASURE position.
- ix. Push the "TIME SETTING" switch the time set in the display to 3 hours.
- x. Lower down the air collection opening cover.
- xi. Push "START/STOP" switch to start measurement.

3.8.2. The following procedures are followed for the maintenance and calibration of direct reading dust meters:

- i. The 1-hour TSP meter was calibrated at 1-year intervals against with high volume sampler.
- ii. Calibration certificates of the Laser Dust Monitors are provided in **Appendix 3-2**. 1-hour validation checking of the TSP meter against HVS is carried out yearly at the air quality monitoring locations.

### **3.9. Monitoring Results and Observations**

3.9.1. The schedule for environmental monitoring in the reporting period is provided in **Appendix 3-6**.

3.9.2. The air quality monitoring results for 1-hour and 24-hour air quality monitoring are summarised in **Table 3-6** and **Table 3-7**. Air quality monitoring data and graphical presentation of the data are provided in **Appendix 3-7**.

**Table 3-6 1-hour Air Quality Monitoring Results in the Reporting Period**

Parameter	Monitoring Station	Average ( $\mu\text{g}/\text{m}^3$ )	Range ( $\mu\text{g}/\text{m}^3$ )
1-hr TSP in $\mu\text{g}/\text{m}^3$	AMS1N	44	16 - 81
	AMS2N1	32	20 - 43
	AMS3N	38	21 - 66
	AMS4N	40	21 - 72

**Table 3-7 24-hour Air Quality Monitoring Results in the Reporting Period**

Parameter	Monitoring Station	Average ( $\mu\text{g}/\text{m}^3$ )	Range ( $\mu\text{g}/\text{m}^3$ )
24-hr TSP in $\mu\text{g}/\text{m}^3$	AMS1N	44	18 - 78
	AMS2N1	32	23 - 40
	AMS3N	38	24 - 63
	AMS4N	40	25 - 69

3.9.3. No Action or Limit Level exceedances of air quality were recorded in the reporting month. No air quality complaints between 0700 – 1900 hours on normal weekdays (i.e., Mondays to Saturdays) were received in the reporting month.

3.9.4. The event and action plan for air quality monitoring are given in **Appendix 3-8**.

### 3.10. Other Influencing Factors of the Monitoring Results

3.10.1. Major emission sources during air quality monitoring in the reporting period were mainly vehicle emission from Po Toi O Chuen Road and nearby residents' activities.

3.10.2. The event and action plan for air quality monitoring are given in **Appendix 3-8**.

## 4. Noise

### 4.1. Monitoring Requirements

4.1.1. In accordance with the EM&A Manual, noise impact monitoring was conducted during daytime construction work on normal weekdays (0700-1900 hours between Monday to Saturday), 1 set of 30-min measurement shall be carried out at approved noise monitoring stations (NMSs) every week based on the measurement procedures under EPD's "Technical Memorandum for the Assessment of Noise from Places Other Than Domestic Premises, Public Places or Construction Sites". The Action and Limit levels for construction noise monitoring is provided in **Table 4-1**.

**Table 4-1 Action and Limit Levels for Construction Noise**

NMSs ID	Noise Sensitive Receivers	Description	Action Level	Limit Level
NMS1N	PTO_N1	Footpath Above House No. 28 Po Toi O Chuen Road	When one documented complaint is received from any one of the noise sensitive receivers	75 dB(A)*
NMS2N1	PTO_N2	Open Space Approx. 15 m from Hung Shing Temple		
NMS3N	PTO_N3	Vacant Land Near Temporary Structure (House) Rocky Shore		
NMS4N	SV_N1	Resting Shelter Near Seacrest Villas		

Note: \*75 dB(A) for residential premises.

### 4.2. Monitoring Equipment

4.2.1. Noise monitoring was completed using sound level meters at each NMSs. The sound level meters deployed comply with the International Electrotechnical Commission Publications (IEC) 651:1979 (Type 1) and 804:1985 (Type 1) specifications. Acoustic calibrator was deployed to calibrate the sound level meters at a given sound pressure level. The equipment used for noise impact monitoring is given in **Table 4-2**.

**Table 4-2 Noise Monitoring Equipment**

Equipment	Brand and Model	Serial No. /Equipment ID
Integrated Sound Level Meter	Rion NL-31	00773032
Integrated Sound Level Meter	Rion NL-52	00998504
Acoustic Calibrator	Rion NC-73	10196943
Anemometer	AZ Instrument – AZ 8908	1064869

### 4.3. Monitoring Locations

4.3.1. Due to the limitation posed by the approved monitoring stations set out by the EM&A manual, alternative monitoring stations NMS1N, NMS2N1, NMS3N and NMS4N were proposed in accordance to Section 4.5.3 of the EM&A Manual of the Project, and approved from the ER and the IEC. The locations of the NMSs are given in **Figure 3-1**, and the details of the monitoring stations are illustrated in **Table 4-3**.

**Table 4-3 Description of Proposed Noise Monitoring Locations**

NMSs ID	Location	Type of measurement	Type of Monitoring	Duration
NMS1N*	Footpath above House No. 28 Po Toi O Chuen Road	Free-field	Noise	30 mins
NMS2N1*	Open space approximately 15 m from Hung Shing Temple			30 mins
NMS3N*	Vacant land near Temporary Structure (House) Rocky Shore			30 mins
NMS4N*	Resting shelter near Seacrest Villas			30 mins

Notes:

\*For Free-field measurement, a correction of +3dB(A) should be made to the measured results.

\* Due to the limitation posed by the approved monitoring stations set out by the EM&A manual, four alternative representative Noise Quality Monitoring Stations (NMSs) are proposed. The alternative monitoring Locations were approved by ER and IEC.

#### 4.4. Monitoring Parameters and Frequency

4.4.1. The monitoring parameters, frequency and duration of impact noise monitoring are summarised in **Table 4-4**.

**Table 4-4 Parameters for Noise Impact Monitoring**

Parameter and Duration	Frequency
30-mins measurement at each monitoring station between 0700 and 1900 on normal weekdays.  $L_{eq}$ , $L_{10}$ and $L_{90}$ would be recorded.	At least once per week

#### 4.5. Monitoring Methodology

4.5.1. The measuring procedures of the sound level meter were in accordance with the Manufacturer's Instruction Manual as follows:

- i. Free-field measurement was made for the noise monitoring stations.
- ii. The sound level meter was set on a tripod at a height of 1.2 m above the ground.
- iii. The battery condition was checked to ensure the correct functioning of the meter.
- iv. Parameters such as frequency weighting, the time weighting and the measurement time were set as follows:
  - a. frequency weighting: A
  - b. Time weighting: Fast
  - c. Time measurement:  $L_{eq}$ (30-minutes) during non-restricted hours i.e., 07:00 – 1900 on normal weekdays;  $L_{eq}$ (5-minutes) during restricted hours i.e., 19:00 – 23:00 and 23:00 – 07:00 of normal weekdays, whole day of Sundays and Public Holidays
- v. Prior to and after each noise measurement, the meter was calibrated using the acoustic calibrator at a specified sound pressure level at a specified frequency. If the difference in the calibration level before and after measurement was more than 1 dB(A), the measurement would be considered invalid and repeat of noise measurement would be required after re-calibration or repair of the equipment.
- vi. During the monitoring period, the  $L_{eq}$ ,  $L_{10}$  and  $L_{90}$  were recorded. In addition, site conditions and noise sources were recorded on a standard record sheet.



- vii. Noise measurement was paused during periods of high intrusive noise (e.g., dog barking, helicopter noise) if possible. Observations were recorded when intrusive noise was unavoidable.
- viii. Noise monitoring was cancelled in the presence of fog, rain, wind with a steady speed exceeding 5m/s, or wind with gusts exceeding 10m/s.

4.5.2. The following procedures are followed for the maintenance and calibration of sound level meters:

- i. The microphone head of the sound level meter was cleaned with soft cloth at regular intervals.
- ii. The meter and calibrator were sent to the supplier or HOKLAS laboratory to check and calibrate at yearly intervals.
- iii. Calibration certificates of the sound level meters and acoustic calibrators are provided in **Appendix 4-1**.

#### 4.6. Monitoring Results and Observations

4.6.1. The schedule for environmental monitoring in the reporting period is provided in **Appendix 3-6**.

4.6.2. The monitoring results for construction noise are summarised in **Table 4-5**. The noise monitoring data graphical presentation of the data is provided in **Appendix 4-2**.

**Table 4-5 Summary of Construction Noise Monitoring Results in the Reporting Period**

NMSs ID	Construction Noise Level, dB(A)*, Leq (30 min)	Baseline Level, dB(A)	Limit Level, dB(A)
NMS1N	60.1 dB(A)	62.7 dB(A)	75
NMS2N1	55.0 dB(A)	61.8 dB(A)	75
NMS3N	59.1 dB(A)	64.6 dB(A)	75
NMS4N	55.4 dB(A)	58.1 dB(A)	75

Note:

\*- A correction of +3 dB(A) was made to the free field measurements. Leq (30min) was measured at 0700-1900 hours on normal weekdays.

4.6.3. No Action or Limit Level exceedance of construction noise was recorded in the reporting month.

No noise complaints from between 0700 – 1900 hours on normal weekdays was received in the reporting month.

4.6.4. The event and action plan are provided in **Appendix 4-3**.

#### **4.7. Other Influencing Factors of the Monitoring Results**

4.7.1. Major noise sources during noise monitoring in the reporting period were mainly road traffic noise.

## 5. Water Quality

### 5.1. Monitoring Requirements

- 5.1.1. With the recommendations of the Project's EIA report, water quality impact monitoring shall be carried out 3 days per week, at mid-flood and mid-ebb tides (within  $\pm 1.75$  hour of the predicted time required) at all the approved Water Quality Monitoring Stations (WQMSs) during whole cofferdam installation/extraction work and during dredging works. The interval between two sets of monitoring shall not be less than 36 hours.
- 5.1.2. Replicate in-situ measurements of Suspended Solids (SS) and in-situ water quality data (temperature, pH, turbidity, water depth, salinity, dissolved oxygen and percentage of saturation) shall be collected.
- 5.1.3. Other relevant data should also be recorded, including monitoring location/position, time, tidal stages, weather conditions and any special observation or works that may affect the monitoring results in the vicinity.
- 5.1.4. To ensure sufficient data for robust analysis, duplicate in-situ data shall be collected. In case the difference in the duplicate in-situ measurement results is larger than 25%, the third set of in-situ measurement shall be carried out for result confirmation purpose.
- 5.1.5. Water samples shall be extracted at 1m below surface, 1m above seabed and the mid-depth level at where the water depth is at least 6m. However, if the water depth is less than 3m, water samples shall only be collected at the mid-depth level. For stations with depth less than 6m, the mid-depth sample can be omitted.
- 5.1.6. In addition, duplicated water samples for suspended solid analysis shall be collected at all the above stations and delivered to the HOKLAS accredited laboratory for analysis. Results for suspended solids shall be received back from the laboratory within 24-hour of the receipt of the samples.
- 5.1.7. Water quality impact monitoring shall also be conducted at the same frequency as monitoring throughout the whole cofferdam installation/extraction work and during dredging work. In case of exceedance of Action/Limit Level recorded, the frequency of water quality monitoring shall be increased as per the Event and Action Plan.
- 5.1.8. The water quality impact monitoring schedule shall be issued to IEC at least one month prior to the commencement of Impact Monitoring.

## 5.2. Monitoring Parameters and Frequency

5.2.1. The monitoring parameters, monitoring periods and frequencies of the water quality monitoring are summarised in **Table 5-1**.

**Table 5-1 Parameters of Water Quality Monitoring**

Parameters	Duration	Frequency
Temperature (°C)	During Construction Phase: Throughout installation and Extraction of Cofferdam; and During Dredging	3 days per week (The interval between two sets of monitoring shall not be less than 36 hours.)
pH (pH unit)		
Turbidity (NTU)		
Water Depth (m)		
Salinity (ppt)		
DO (mg/l and % of Saturation)		
SS (mg/l)		

## 5.3. Monitoring Locations

5.3.1. According to section 5.2.6 of the EM&A manual of the project, 6 water quality monitoring stations (WMSs) are proposed at the Po Toi O FCZs, major amphioxus habitats and rocky shores where coral thrives. With reference to the tidal characteristics of Po Toi O Bay, 3 control stations are proposed where fresh marine water is not affected by the cofferdam installation/ extraction works, and 2 impact stations are proposed near the cofferdam under different tidal periods. All water quality monitoring stations show as **Figure 5-1** and **Table 5-2**.

**Table 5-2 Summary of Water Quality Impact Monitoring Stations**

Station	Monitoring Period	Description	Easting	Northing
*WMS1N	Mid-Ebb, Mid-Flood	Po Toi O Fish Culture Zone	848416	845209
*WMS2N	Mid-Ebb, Mid-Flood	Po Toi O Fish Culture Zone	848505	815375
WMS3	Mid-Ebb, Mid-Flood	Rocky Shore with Corals	848644	815391
WMS4	Mid-Ebb, Mid-Flood	Rocky Shore with Corals	848774	815602
WMS5	Mid-Ebb, Mid-Flood	Rocky Shore with Corals	848578	815591
WMS6	Mid-Ebb, Mid-Flood	Major Amphioxus Habitat	848639	815523
I1	Mid-Flood	Impact monitoring Station	848643	815692
I2	Mid-Ebb	Impact monitoring Station	848722	815910
C1	Mid-Flood	Control station	848904	816052
C2	Mid-Ebb	Control station	848529	815373
C3	Mid-Ebb	Control station	848243	815710
WMS1	Mid-Ebb, Mid-Flood	Po Toi O Fish Culture Zone	848387	815201
WMS2	Mid-Ebb, Mid-Flood	Po Toi O Fish Culture Zone	848479	815378

Notes:

\*WMS1N, WMS2N are new proposed alternative monitoring location. As previous EIA proposed monitoring location WMS1, WMS2 are situated in fish barges within the Fish Culture Zone (FCZ), and accesses to WMS1 and WMS2 were subsequently denied by the tenants of the fish barges. The relocation of WMS1 and WMS2 were approved by IEC and the ER of the Project.

#### 5.4. Results and Observations

5.4.1. According to submission of construction works schedule and location plan under the EP of Project, the proposed period of commencement construction work with cofferdam installation / extraction work and during dredging works is August 2022.

5.4.2. Marine construction was not commenced within the reporting month; hence no water quality monitoring was conducted.

5.4.3. Refer to Sections 5.2.10 and 5.2.11 of approved EM&A Manual, construction phase site inspection for water quality mitigation measures and check the contractor's work practice on water pollution prevention during construction phase has been conducted during weekly site audit.

5.4.4. During the weekly site audit of this reporting month, no non-conformance water pollution was identified / observed in the commencement works area.

## 6. Environmental Site Inspection and Audit

### 6.1. Site Inspection

6.1.1. Site inspections were carried out by ET on a weekly basis to monitor the implementation of proper environmental pollution control and mitigation measures for the Project. Key observations were recorded in the site inspection checklist and passed to the Contractor together with the appropriate recommended mitigation measures where necessary.

6.1.2. In the reporting period, 4 site inspections were carried out on 5, 12, 19 and 26 May 2022. A joint site inspection with IEC was carried out on 19 May 2022. No non-compliance was recorded during the site inspection. Details of observations recorded during the site inspections are presented in **Table 6-1**.

**Table 6-1 Observations and Recommendations in the Reporting Month**

Parameters	Date	Observations and Recommendations	Action taken by contractor
Water Quality	5 May 2022	<b><u>Reminder</u></b> Refer to the 9-day weather forecast report, it is noted that there will be frequent showers in coming days, the contractor has been reminded to maintain silt removal facilities, channels, manholes before and after rainstorm.	<b><u>Follow up Observation</u></b> It is observed during site inspection on 13 May 2022, the contractor was maintained silt removal facilities, channels, manholes before and after rainstorm.  <b>(Item closed)</b>

Parameters	Date	Observations and Recommendations	Action taken by contractor
Water Quality	13 May 2022	<p><b><u>Reminder</u></b></p> <p>It is observed during site inspection on 13 May 2022, open cut excavation works for laying of gravity sewers/rising mains was conducted nearby the rocky shore, the contractor has been reminded to place sandbag along rocky shore during open cut excavation for laying of gravity sewers/rising mains nearby the rocky shore.</p>	<p><b><u>Follow up Observation</u></b></p> <p>It is observed during site inspection on 19 May 2022, the contractor has been placed sandbag along rocky shore during open cut excavation for laying of gravity sewers/rising mains nearby.</p> <p><b>(Item closed)</b></p>
Water Quality	19 May 2022	<p><b><u>Observation</u></b></p> <p>It is observed during the site inspection on 19 May 2022, catchpit was not provided in the lowest point of the STP works area. The contractor has been reminded to setting the sand/silt removal facilities such as sand traps, silt traps and sedimentation basin for the works area to prevent overflowing.</p>	<p><b><u>Follow up Observation</u></b></p> <p>It is observed during the site inspection on 26 May 2022, the contractor has been set the silt traps for the PTO STP works area to prevent overflowing.</p> <p><b><u>(Item Closed)</u></b></p>
Air Quality	28 April 2022	<p><b><u>Reminder</u></b></p> <p>It is observed during the site inspection on 29 April</p>	<p><b><u>Follow up reminder</u></b></p> <p>It is observed on 5 May 2022, the contractor was</p>

Parameters	Date	Observations and Recommendations	Action taken by contractor
		2022, open stockpiles were storage in the PTO 031 works area. The Contractor has been reminded to cover open stockpiles of construction with impermeable materials such as tarpaulin during rainstorms.	covered the open stockpiles of construction in the PTO 031 works area with impermeable materials such as tarpaulin.  <b>(Item Closed)</b>
Air Quality	19 May 2022	<b><u>Reminder</u></b> It is observed during site inspection on 19 May 2022, open stockpile was temporary storage in PTO032 works area. The contractor has been reminded to cover open stockpiles of construction materials with impermeable materials such as tarpaulin.	<b><u>Follow up Observation</u></b> It is observed during site inspection on 26 May 2022, the contractor has been covered open stockpiles of construction materials with impermeable materials such as tarpaulin in PTO032 works area.  <b>(Item Closed)</b>
Air Quality	26 May 2022	<b><u>Reminder</u></b> It is observed during site inspection on 26 May 2022, open excavation works for pipe laying was conduct in PTO056 works area. The contractor has been reminded to maintain good housekeeping to minimize dust generation, e.g. by	<b><u>Follow up reminder</u></b> This item will be reinspected in the next weekly site inspection.



Parameters	Date	Observations and Recommendations	Action taken by contractor
		properly handling and storing dusty materials.	
Noise impact	No adverse observation was identified in the reporting period.		
Ecology	No adverse observation was identified in the reporting period.		
Fisheries	No adverse observation was identified in the reporting period.		
Built Heritage	No adverse observation was identified in the reporting period.		
Landscape & Visual	No adverse observation was identified in the reporting period.		
Miscellaneous	No adverse observation was identified in the reporting period.		

**6.1.3.** The surprise site inspection was carried out by IEC team on 16 May 2022 and the joint site inspection was carried on 19 May 2022. Total 4 numbers of observations were recorded during the surprise site inspection. Total 1 number of observations and 1 number of reminders were recorded during the joint site inspection. The rectification action was taken by contractor and inspected by ET on 17 May 2022 and 26 May 2022. Details of observations recorded and reminder during the surprise site inspections and the joint site inspection are presented in **Table 6-2**.

**Table 6-2 IEC Surprise Site inspection Observations and Recommendations in the Reporting Month**

Parameters	Date	Observations and Recommendations	Action taken by contractor
Water Quality	16 May 2022	<p><b><u>Observations 1</u></b></p> <p>IEC team was observed during the surprise site inspection on 16 May 2022, At the PTO STP location, catchpit should be constructed to avoid wastewater inside the site area from leaving outside.</p>	<p><b><u>Follow up Observation</u></b></p> <p>It was observed by ET during site inspection on 17 May 2022, that the contractor constructed the catch pit inside the PTO STP works area. It is further advised to the contractor the catch pit should be set in the lowest point of the STP works area. This item will</p>

Parameters	Date	Observations and Recommendations	Action taken by contractor
			be reinspected during the coming weekly inspection, supplementary photo records will be provided.  <b>(Item Closed)</b>
Miscellaneous	16 May 2022	<b><u>Observation 2</u></b>  IEC team was observed during the site inspection on 16 May 2022, the construction materials should be placed inside in the construction site at PTO 005.	<b><u>Follow up Observation</u></b>  It is observed by ET during site inspection on 17 May 2022, the contractor was placed the construction materials inside the construction site.  <b>(Item Closed)</b>
Miscellaneous	16 May 2022	<b><u>Observation 3</u></b>  IEC team was observed during the site inspection on 16 May 2022, the chemical materials should be placed on the drip tray.	<b><u>Follow up Observation</u></b>  It was observed by ET during site inspection on 17 May 2022, the contractor has removed the chemicals materials from the captioned site area.  <b>(Item Closed)</b>
Water Quality	16 May 2022	<b><u>Observation 4</u></b>  IEC team was observed during the site inspection on 16 May 2022, the site area should increase	<b><u>Follow up observation</u></b>  It was observed by ET during site inspection on 17 May 2022, the contractor was increased

Parameters	Date	Observations and Recommendations	Action taken by contractor
		sandbags to prevent sand and wastewater spread out of the site area at PTO032.	the numbers of the sandbags and along the PTO032 work front.  <b>(Item Closed)</b>
Water Quality	19 May 2022	<b><u>Observation 1</u></b>  IEC team was observed during the site inspection on 19 May 2022, at the lowest point of PTO SPT site area, sufficient catch pits should be constructed to prevent overflowing of on-site runoff and muddy water.	<b><u>Follow up observation</u></b>  It is observed by ET during site inspection on 26 May 2022, the contractor was constructed the catch pit at the lowest point of PTO STP works area.  <b>(Item Closed)</b>
Air Quality	19 May 2022	<b><u>Reminder</u></b>  IEC team was reminded the contractor to cover stockpiles after works on 19 May 2022 join site inspection,	<b><u>Follow up observation</u></b>  It is observed by ET during site inspection on 26 May 2022, the contractor was covered stockpile after works.  <b>(Item Closed)</b>

## 6.2. Waste Management

6.2.1. As advised by the Contractor, 64m<sup>3</sup> of inert C&D material was generated in the reporting month. For C&D wastes, 2 m<sup>3</sup> of general refuse was disposed of at NENT landfill, 0 kg waste were collected by recycling contractors, and 0 kg of chemical wastes was collected by licensed Contractors in the reporting period.

6.2.2. The actual amounts of different types of waste generated by the activities of the Project in the reporting period are shown in **Table 6-3**, the detailed monthly summary of waste flow is detailed in **Appendix 6-1**.

**Table 6-3 Summary of Waste Flow Table**

Waste Type	Quantity	Disposal/ Reuse Locations
Inert C&D Waste Disposed as Public Fill	64 m <sup>3</sup>	Tseung Kwan O Area 137 Fill Bank (TKO137FB).
C&D Wastes Disposed as General Refuse	2 m <sup>3</sup>	North East New Territories (NENT)
Recycle Materials	0 kg	Recycling Facilities
General Refuse	0 kg	North East New Territories (NENT)
Chemical Waste	0 kg	Licensed Contractors

6.2.3. During regular site auditing, the mitigation measures proposed in the Implementation Schedule of the Environmental Mitigation Measures (EMIS) in the approved EIA report of the Project has been effectively implemented in the commenced works area. No adverse waste impact was observed from the construction works in reporting month.

### 6.3. Status of Environmental Licenses, Notification and Permits

6.3.1. The environmental licenses and permits for the Project and valid in the reporting period are summarized in **Table 6-4**.

**Table 6-4 Status of Environmental License, Notification and Permit**

License/ Notification/ Permit	Reference No.	Valid Period	
		From	To
Environmental Permit	EP-516/2016	27 January 2017	End of Project
Construction Dust Notification Under APCO	458613	3 August 2020	N/A
Wastewater Discharge License	WT00038707-2021	3 November 2021	31 August 2026
Chemical Waste Producer Registration	5213-820-C3510- 18	23 September 2020	N/A
Billing Account for Disposal of Construction Waste	WFG22785	17 August 2020	N/A

### 6.4. Implementation Status on Environmental Protection Requirements

6.4.1. The Implementation Schedule of the Environmental Mitigation Measures (EMIS) of the reporting period is summarized in **Appendix 6-2**. The implementation of the key mitigation measures during the reporting period is presented in **Appendix 6-3**.

### 6.5. Summary of Complaints, Notification of Summons, Successful Prosecutions and Public Engagement Activities

6.5.1. No complaints, notification of summons and successful prosecution was received in the reporting period. No public engagement activities were conducted in the reporting period.

6.5.2. Statistics on complaints, notifications of summons, successful prosecutions and public engagement activities are summarized in **Appendix 6-4**.

## 7. Future Key Issues

### 7.1. Construction Programme for the Upcoming Reporting Month

-Major activities in the upcoming month:

- a) Construction of village sewer;
- b) Slope works.
- c) Construction of temporary working platform and installation of silt curtain for HDD.

### 7.2. Reinstatement Works Key Issues for the Upcoming Reporting Month

7.2.1. Potential environmental impacts due to the construction activities, including air quality, noise, water quality, waste, landscape and visual, will be monitored or reviewed. The ET will continue to implement the environmental monitoring & audit programme in accordance with the EM&A Manual and Environmental Permit requirement. The recommended environmental mitigation measures shall be implemented on site and regular inspections as required will be carried out to ensure that the environmental conditions are acceptable.

7.2.2. The anticipated impact of major work activities within the site and the recommended mitigation measures are shown in **Appendix 6-4**.

### 7.3. Monitoring Schedule for the Coming Month

7.3.1. The tentative schedule for environmental monitoring in June 2022 is provided in **Appendix 3-6**.

## **8. Conclusion**

### **8.1. General**

8.1.1. This report summarized the monitoring results and audits findings of the EM&A programme under the EP of the Project and in accordance with the EM&A Manual during the reporting period of 1 May 2022 to 31 May 2022.

### **8.2. Environmental Impact Monitoring**

8.2.1. No Action or Limit Level exceedance of construction air quality, noise was recorded in the reporting month. No air quality complaints and noise complaints during 0700 – 1900 hours on normal weekdays was received in the reporting month.

### **8.3. Environmental Site Inspections**

8.3.1. The environmental site inspections were carried out in the reporting month. Recommendations on remedial actions were given to the contractors for the deficiencies identified during the site inspection. The contractor had been follow-up the recommendations on the remedial action accordingly.

### **8.4. Complaint Log**

8.4.1. There was no complaint received in relation to the environmental impact during the reporting period.

### **8.5. Reporting Changes**

8.5.1. No report changes in this reporting period.

### **8.6. Notifications of Summons and Successful Prosecutions**

8.6.1. There was no notification of summons and successful prosecution was received in the reporting period

**Figure 2-1**

---

*Layout Plan of the Captioned Project*



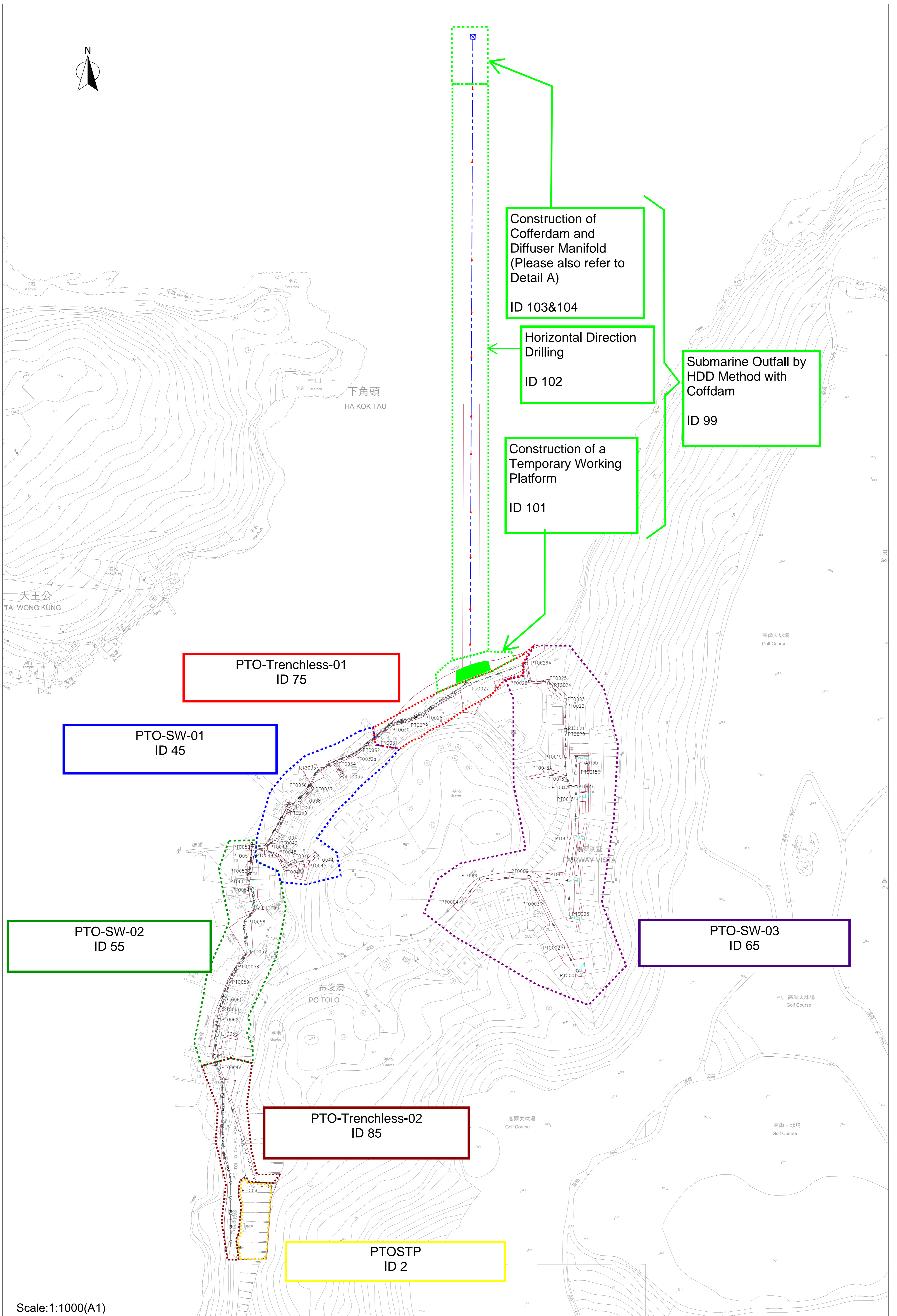
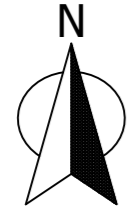

Construction of Cofferdam and Diffuser Manifold (Please also refer to Detail A)  
ID 103&104

Horizontal Direction Drilling  
ID 102

Submarine Outfall by HDD Method with Coffdam  
ID 99

Construction of a Temporary Working Platform  
ID 101

PTO-Trenchless-01  
ID 75

PTO-SW-01  
ID 45

PTO-SW-02  
ID 55

PTO-SW-03  
ID 65

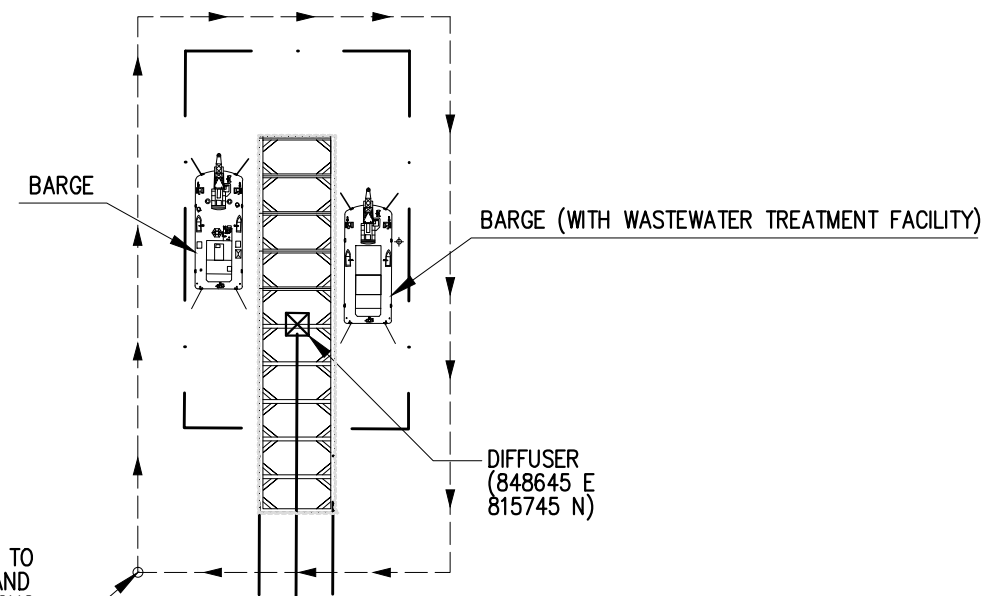

PTO-Trenchless-02  
ID 85

PTOSTP  
ID 2



INSTALLATION OF SHEET PILES TO BE COMMENCED FROM HERE, AND THEN FOLLOWS THE ARROW SIGNS IN CLOCKWISE DIRECTION.

Construction of Cofferdam and Diffuser Manifold

- LEGEND:**
-  EFFLUENT PIPELINE
  -  WORKS LIMIT
  -  DIFFUSER

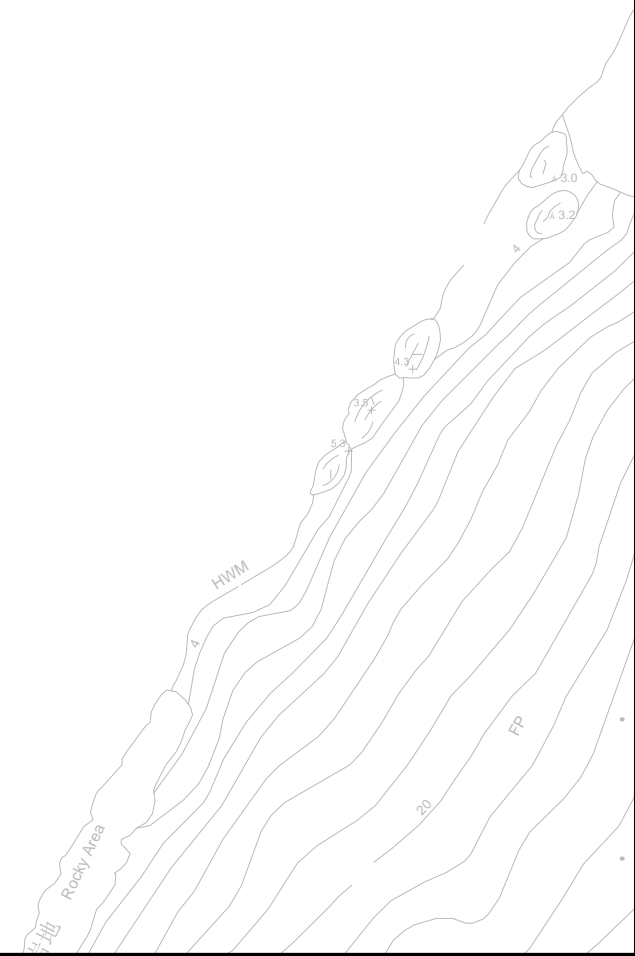

Drawing title  
**DETAIL A - LOCATION PLAN FOR COFFERDAM CONSTRUCTION**

Scale 1:1000 A3

NOTE:  
1. FOR GENERAL NOTES, REFER TO 382770/B&V/GN/000.

LEGEND:  
 - - - - - EFFLUENT PIPELINE  
 // // // // // FINAL EFFLUENT PIPELINE BY TRENCHLESS METHOD  
 - - - - - WORKS LIMIT

Revision	Date	Description			Initial
		Designed	Checked	Drawn	Checked
Initial	WC	WL	SZ	CC	
Date	03/20	03/20	03/20	03/20	03/20

Contract no. DC/2019/09

Contract title  
PROVISION OF VILLAGE SEWERAGE IN SAI KUNG

Drawing title  
PO TOI O - PROPOSED SUBMARINE OUTFALL LAYOUT PLAN

Drawing no. 382770/B&V/PTOSTP/SO/001  
Revision A

Scale A1 1 : 1000  
A3 1 : 2000

香港特別行政區政府渠務署  
THE GOVERNMENT OF THE HONG KONG  
SPECIAL ADMINISTRATIVE REGION  
DRAINAGE SERVICES DEPARTMENT

BLACK & VEATCH HONG KONG LIMITED  
博威工程顧問有限公司

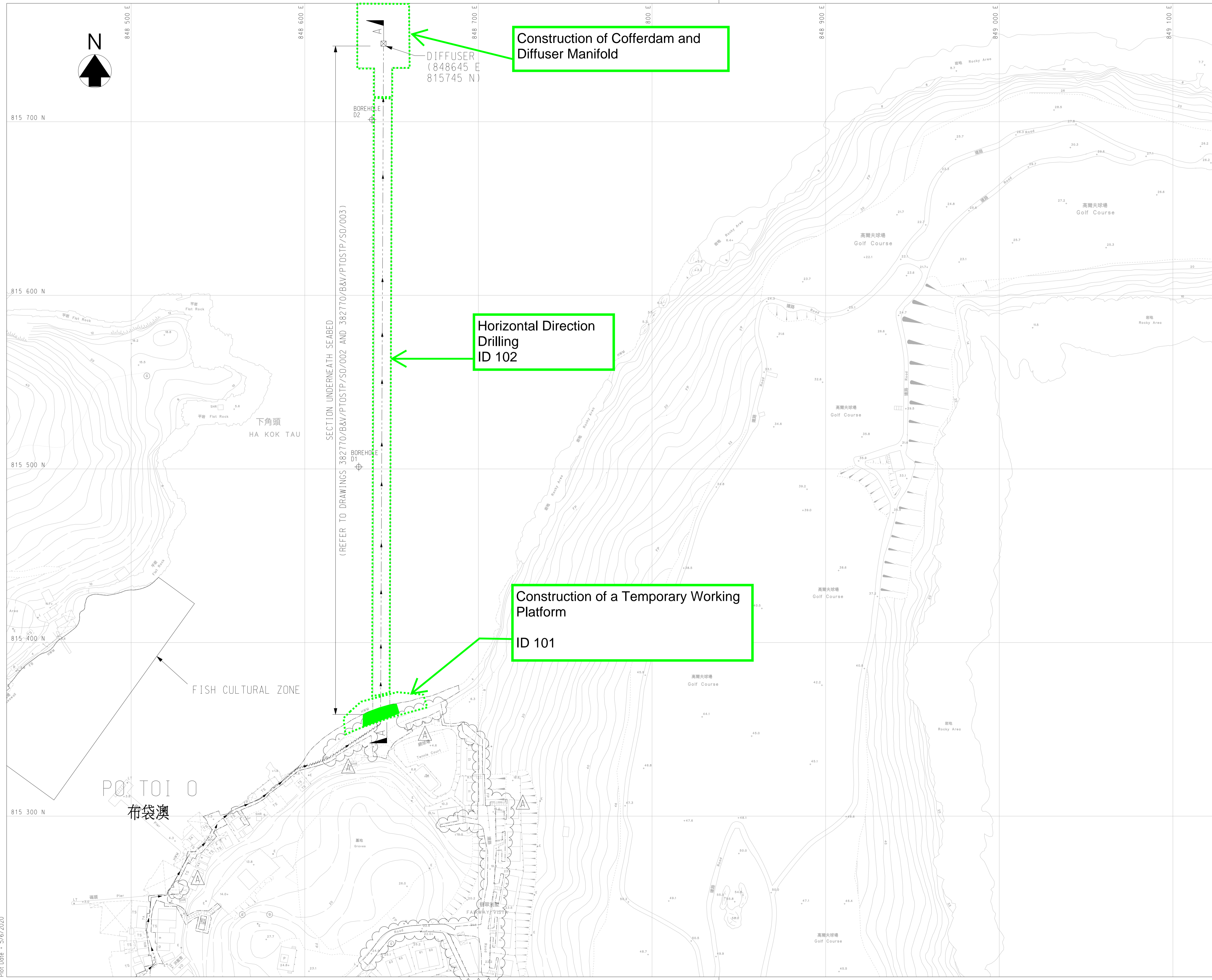





Plot Date - 5/6/2020

NOTES:

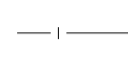
1. FOR OTHER NOTES AND LEGEND, REFER TO DRAWING NO. 382770/B&V/GN/000.
2. ALL LEVELS ARE IN METERS ABOVE PRINCIPAL DATUM (MPD).
3. ALL DIMENSIONS ARE IN MILLIMETERS UNLESS OTHERWISE SPECIFIED.

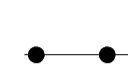
LEGEND:

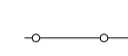
-  PROPOSED 3m HEIGHT FENCE WALL
-  PROPOSED TREE
-  PROPOSED CUT SLOPE
-  BOUNDARY FENCE (REFER TO ARCHITECTURAL DRAWINGS FOR THE TYPES AND DETAILS)
-  WORKS LIMIT
-  STAINLESS STEEL RAILINGS

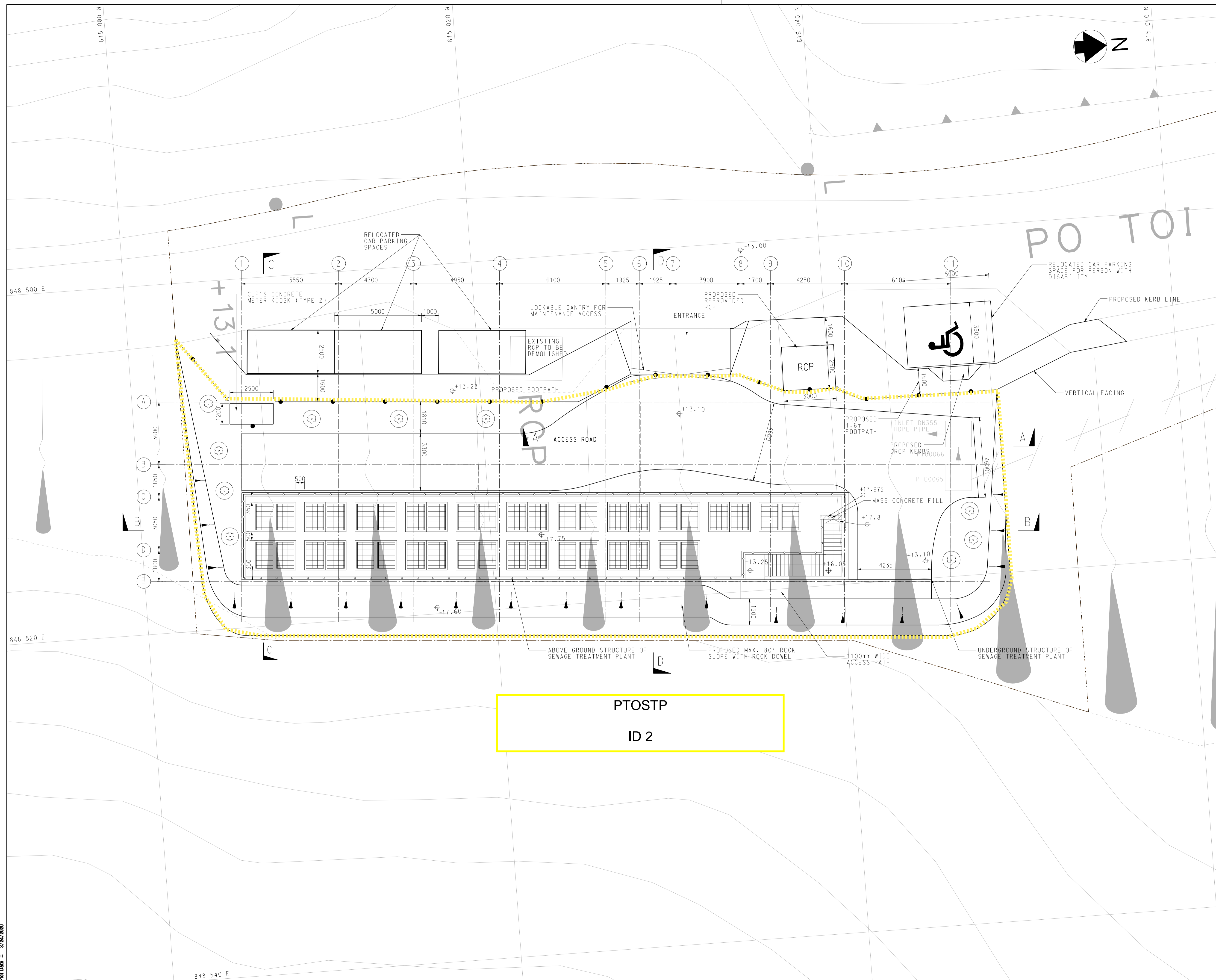

PTOSTP  
ID 2

Revision	Date	Description	Initial
Initial	Designed	Checked	Drawn
Initial	WC	WL	SZ
Date	03/20	03/20	03/20
Approved			

Contract no. **DC/2019/09**

Contract title  
**PROVISION OF VILLAGE SEWERAGE IN SAI KUNG**

Drawing title  
**GENERAL ARRANGEMENT OF PO TOI O SEWAGE TREATMENT PLANT - GENERAL LAYOUT**

Drawing no. **382770/B&V/PTOSTP/GA/001**      Revision **-**

Scale  
A1 1 : 100  
A3 1 : 200



**Figure 3-1**

---

*Proposed Air Quality and Noise Monitoring Stations Locations*



布袋澳  
PO TOI O

Agreed AMS2N1/NMS2N1

Agreed AMS3N /NMS3N

Agreed AMS1N/NMS1N

Agreed AMS4/NMS4

AMS1/NMS1

AMS2/NMS2

AMS3/NMS3

AMS4/NMS4







EXISTING DRAINAGE SYSTEM

高爾夫球場  
Golf Course

0 10 20 50m



NOTES :

-  Proposed Work Boundary
-  Proposed Sewer and Manhole
-  Proposed Rising Main
-  Proposed Sewer by Trenchless Method
-  Proposed Sewage Treatment Plant
-  Air/Noise Monitoring Stations Proposed in EM&A Manual
-  Agreed Air/Noise Monitoring Stations

AMS1N/NMS1N

Consultant



Allied Environmental Consultants Limited  
ACOUSTICIANS & ENVIRONMENTAL ENGINEERS

Project No. : 1825

File Name :

Project :

Air Quality, Noise and Water Quality  
Baseline Monitoring Report for Port  
Shelter Phase 3- Po Toi O Sewerage  
Treatment Plant

Drawing Title :

Location of Air Quality and Noise  
Monitoring Station

Drawing No. :  
Figure 3-1

Revision :  
1

Scale :  
NTS

Date :  
April 2021

DO NOT SCALE OFF DRAWING. THIS DRAWING IS NOT FOR  
CONSTRUCTION PURPOSES UNLESS EXPRESSLY STATED.  
ALL RIGHTS RESERVED AND REPRODUCTION IN ANY FORM MUST BE  
APPROVED BY ALLIED ENVIRONMENTAL CONSULTANTS LIMITED.

**Figure 5-1**

---

*Locations of Water Quality Impact Monitoring Stations*



Proposed Diffuser

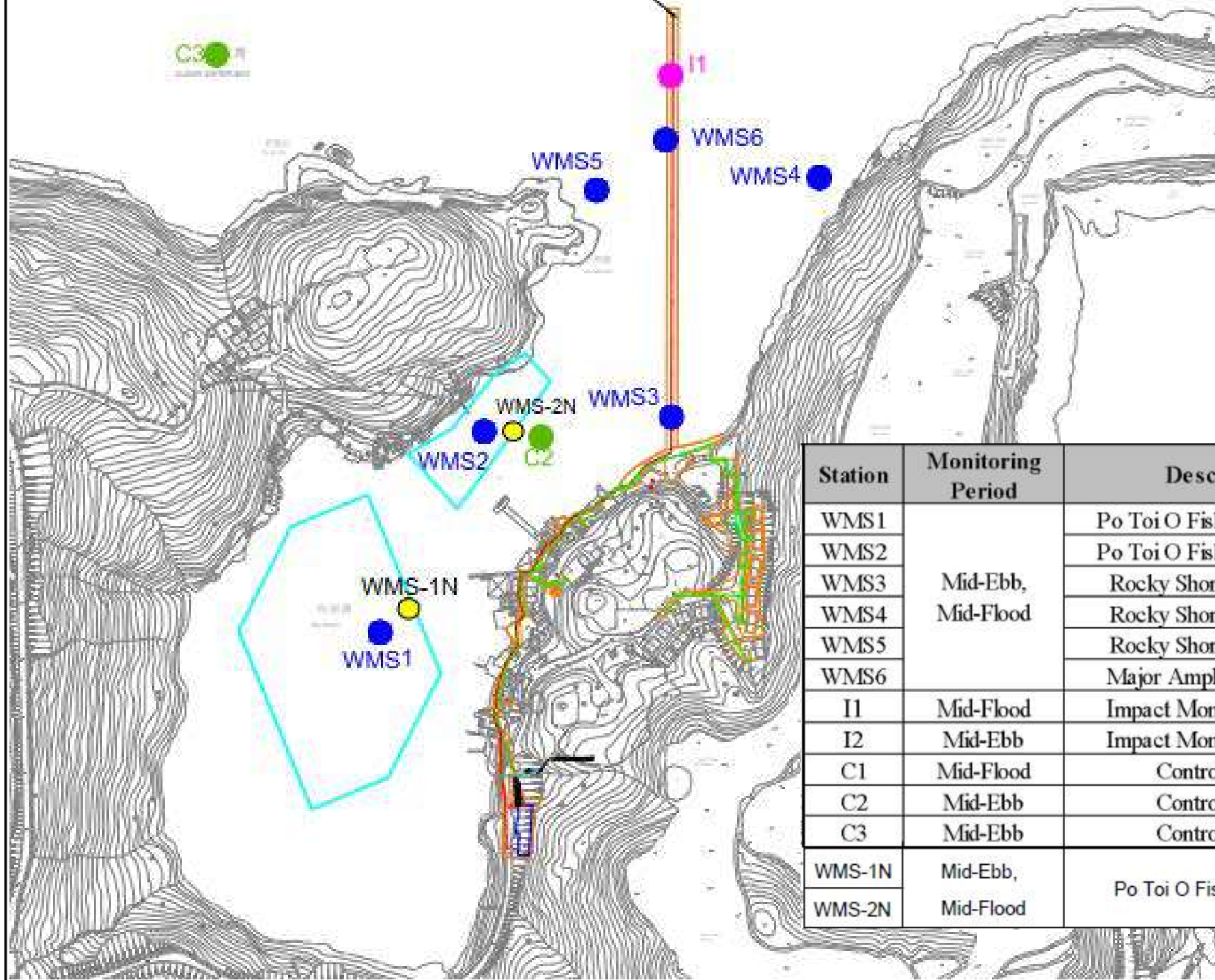

- NOTES:
- Proposed Work Boundary
  - Proposed Sewer and Manhole
  - Proposed Rising Main
  - Proposed Sewer by Trenchless Method
  - Proposed Sewage Treatment Plant
  - Po Toi O Fish Culture Zone
  - Water Monitoring Point

Station	Monitoring Period	Description	Easting	Northing
WMS1	Mid-Ebb, Mid-Flood	Po Toi O Fish Culture Zone	848387	815201
WMS2		Po Toi O Fish Culture Zone	848479	815378
WMS3		Rocky Shore with Corals	848644	815391
WMS4		Rocky Shore with Corals	848774	815602
WMS5		Rocky Shore with Corals	848578	815591
WMS6		Major Amphioxus Habitat	848639	815523
I1	Mid-Flood	Impact Monitoring Station	848643	815692
I2	Mid-Ebb	Impact Monitoring Station	848722	815810
C1	Mid-Flood	Control Station	848904	816052
C2	Mid-Ebb	Control Station	848529	815373
C3	Mid-Ebb	Control Station	848243	815710
WMS-1N	Mid-Ebb, Mid-Flood	Po Toi O Fish Culture Zone	848416	815209
WMS-2N			848505	815375

Consultant



**Allied Environmental Consultants Limited**  
ACousticians & ENVIRONMENTAL ENGINEERS

Project No.:	1825
File Name:	
Project:	Air Quality, Noise and Water Quality Baseline Monitoring Report for Port Shelter Phase 3- Po Toi O Sewerage Treatment Plant
Drawing Title:	Location of Water Quality Monitoring Stations
Drawing No.:	Figure 5-1
Revision:	0
Scale:	NTS
Date:	April 2021

DO NOT SCALE OFF DRAWING. THIS DRAWING IS NOT FOR CONSTRUCTION PURPOSES UNLESS EXPRESSLY STATED. ALL RIGHTS RESERVED AND REPRODUCTION IN ANY FORM MUST BE APPROVED BY ALLIED ENVIRONMENTAL CONSULTANTS LIMITED.



***Appendix 2-1***

---

*Project Organization Chart*

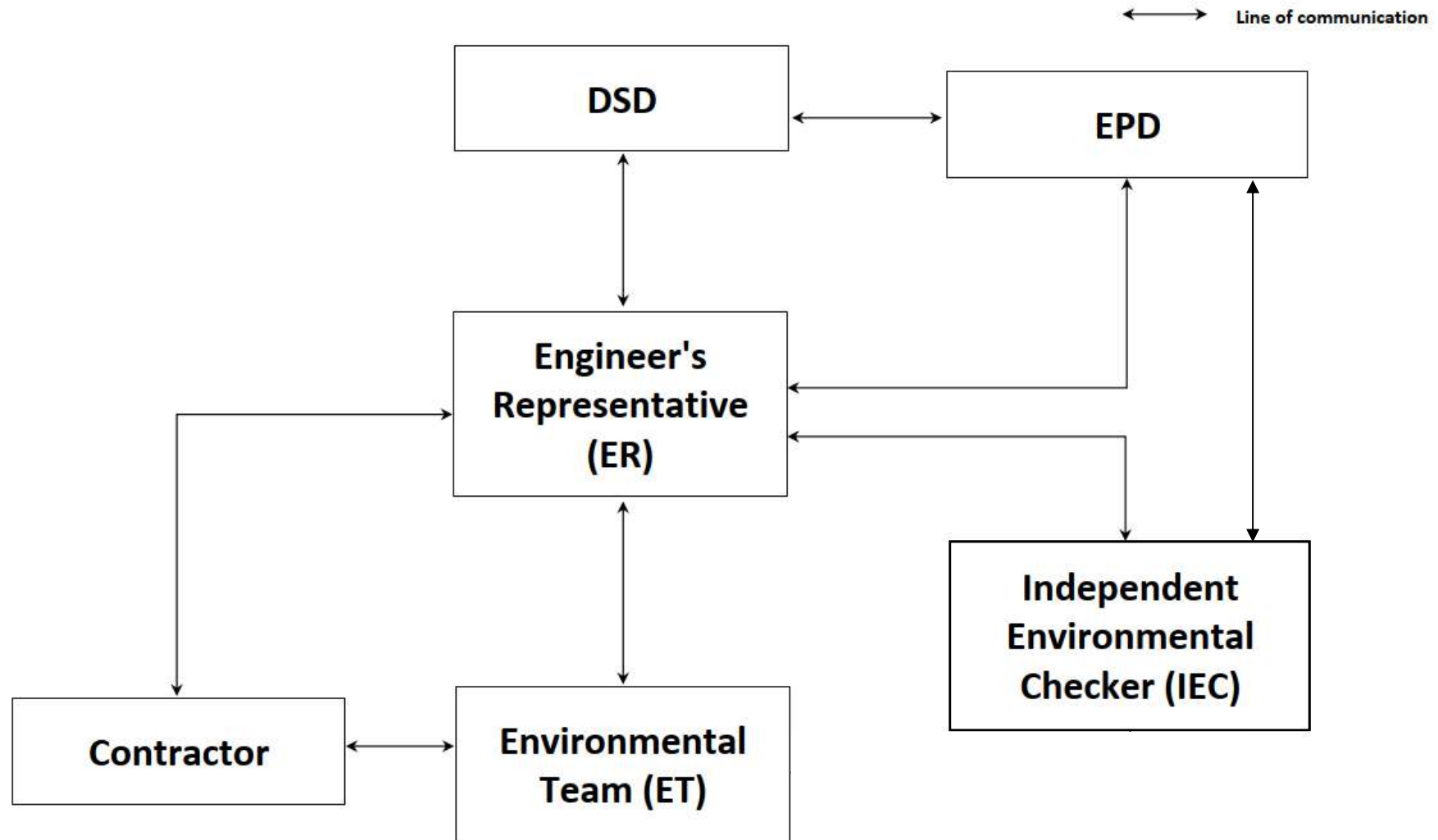

***Appendix 2-2***

---

*Construction Works Programme*

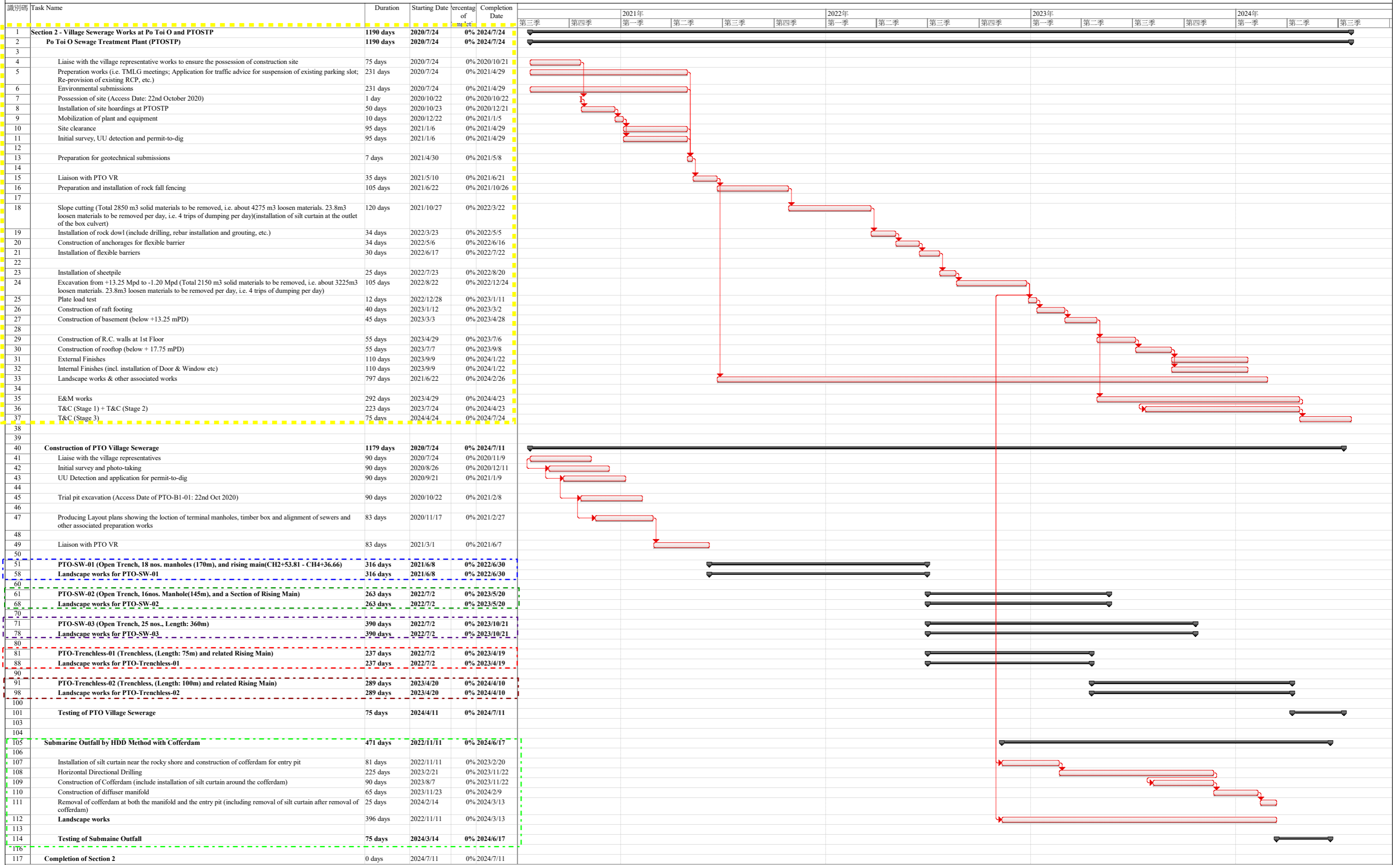

***Appendix 3-1***

---

*Meteorological Data*

## Appendix 3-1 Daily Extract of Meteorological Observations, May 2022

Day	Hong Kong Observatory						King's Park		Waglan Island <sup>^</sup>		
	Mean Pressure (hPa)	Air Temperature		Mean Dew Point (deg. C)	Mean Relative Humidity (%)	Mean Amount of Cloud (%)	Total Rainfall (mm)	Total Bright Sunshine (hours)	Prevailing Wind Direction (degrees)	Mean Wind Speed (km/h)	
		Absolute Daily Max (deg. C)	Mean (deg. C)								Absolute Daily Min (deg. C)
1	1012.6	24.6	20.7	17.1	18.8	89	94	32.4	-	010	41.7
2	1014.6	21.3	18.5	16.4	15.7	84	93	23.4	-	010	32.0
3	1015.8	26.6	22.3	18.8	14.6	62	61	-	11.3	080	25.2
4	1014.3	28.5	24.6	21.6	16.8	63	48	-	11.0	070	28.5
5	1012.6	29.3	25.2	23.2	19.9	73	76	-	10.7	080	18.7
6	1012.4	28.9	25.5	23.4	20.7	76	73	-	10.8	080	16.6
7	1013.0	29.7	25.4	23.6	20.9	77	85	0.8	4.7	070	19.6
8	1013.2	27.5	25.0	23.4	19.1	70	83	Trace	1.8	080	29.9
9	1012.3	29.0	25.6	24.3	20.8	75	86	Trace	4.9	080	22.4
10	1009.7	27.7	25.7	24.4	23.6	88	88	1.4	1.0	110	21.6
11	1007.8	25.9	25.0	24.2	24.1	95	91	61.4	-	140	26.5
12	1006.0	27.0	25.8	24.6	24.2	91	96	123.5	-	220	29.8
13	1005.2	26.9	25.5	24.3	24.1	92	92	107.1	0.5	240	23.4
14	1008.2	26.5	24.6	23.5	23.5	93	89	5.0	0.3	080	23.2
15	1009.8	24.9	22.6	20.8	21.1	91	91	26.2	1.0	070	42.5
16	1012.4	20.8	20.0	18.8	17.5	85	85	4.7	-	010	30.3
17	1013.6	26.3	22.4	19.6	16.9	72	67	-	5.4	080	24.3

Day	Hong Kong Observatory						King's Park		Waglan Island <sup>^</sup>		
	Mean Pressure (hPa)	Air Temperature			Mean Dew Point (deg. C)	Mean Relative Humidity (%)	Mean Amount of Cloud (%)	Total Rainfall (mm)	Total Bright Sunshine (hours)	Prevailing Wind Direction (degrees)	Mean Wind Speed (km/h)
		Absolute Daily Max (deg. C)	Mean (deg. C)	Absolute Daily Min (deg. C)							
18	1013.8	27.1	23.9	21.9	13.3	52	71	-	4.9	070	36.0
19	1011.9	30.0	25.8	23.5	18.2	64	77	-	7.1	070	22.6
20	1009.2	30.9	26.9	24.5	22.1	76	55	-	9.6	040	11.0
21	1007.8	30.7	26.9	24.6	22.6	78	72	-	9.5	240	11.0
22	1007.3	27.2	25.0	24.1	21.9	83	88	0.6	1.5	080	36.7
23	1007.6	24.8	24.0	23.1	22.3	90	89	11.2	-	080	38.8
24	1009.2	25.0	24.4	23.7	23.3	93	92	10.3	0.1	070	33.9
25	1007.7	27.4	25.3	23.8	23.7	91	90	1.3	1.8	080	19.2
26	1004.7	28.6	26.7	25.1	24.6	88	86	2.4	3.6	080	11.2
27	1004.3	28.5	27.4	26.1	25.3	89	88	24.7	-	200	18.5
28	1005.5	31.3	28.7	27.1	25.2	81	78	Trace	5.2	160	16.0
29	1005.8	32.2	29.1	27.8	25.1	79	80	Trace	7.9	160	16.2
30	1005.9	32.7	29.2	27.4	24.9	78	84	Trace	7.4	150	11.8
31	1006.8	30.7	28.2	27.4	24.9	82	87	0.1	2.6	160	11.5
Mean/Total	1009.7	27.7	25.0	23.3	21.3	81	82	436.5	124.6	080	24.2

<sup>^</sup>The prevailing wind direction is the wind direction most frequently observed during the period.

All data were recorded at the Hong Kong Observatory except sunshine duration which was recorded at King's Park and winds at Waglan Island. \*\*\* unavailable

Source: <https://www.weather.gov.hk/wxinfo/pastwx/metob202205.htm>

***Appendix 3-2***

---

*Air Quality Monitoring Equipment Calibration Cert*





**Internal Calibration Report**  
of  
**Dust Monitor**

Manufacturer : SIBATA (LD-3B) Date of Calibration : 25 April 2022

Serial No. : 014746 (ET/EA/001/06) Calibration Due Date : 24 June 2022

Method : Parallel measurement (Five-point calibration) by placing the Dust Monitor and High Volume Air Sampler together under the same environmental condition

Results	Dust Monitor (CPM)	25	50	77	134	178
	TSP (ug/m <sup>3</sup> )	46	92	139	227	315
High Volume Air Sampler Serial No.: 1180		Calibration Due Date: 07 May 2022				

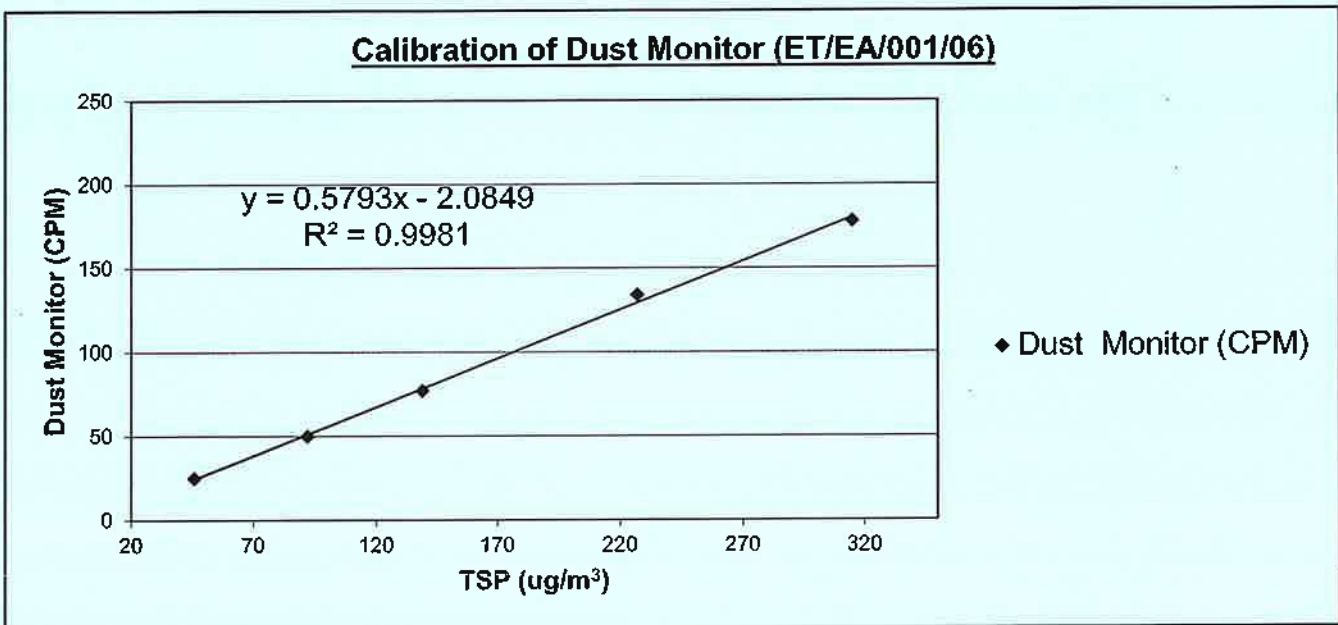

Acceptance Criteria : Correlation coefficient (r) of the calibration curve greater than 0.990 after five-point calibration.

The Dust Trak Monitor complies \* / ~~does not comply~~ \* with the internal calibration procedures and is deemed acceptable \* / ~~unacceptable~~ \* for use.

Calibrated by :   
Li, Lok Yin  
(Senior Technician)

Checked by :   
Guy, Kong Ping Ki  
(Laboratory Manager)



**Internal Calibration Report**  
of  
**Dust Monitor**

Manufacturer : SIBATA (LD-3B) Date of Calibration : 25 April 2022

Serial No. : 155331 (ET/EA/001/09) Calibration Due Date : 24 June 2022

Method : Parallel measurement (Five-point calibration) by placing the Dust Monitor and High Volume Air Sampler together under the same environmental condition

Results	Dust Monitor (CPM)	50	102	159	206	271
	TSP (ug/m <sup>3</sup> )	64	113	182	247	315
	High Volume Air Sampler Serial No.: 9795	Calibration Due Date: 08 May 2022				

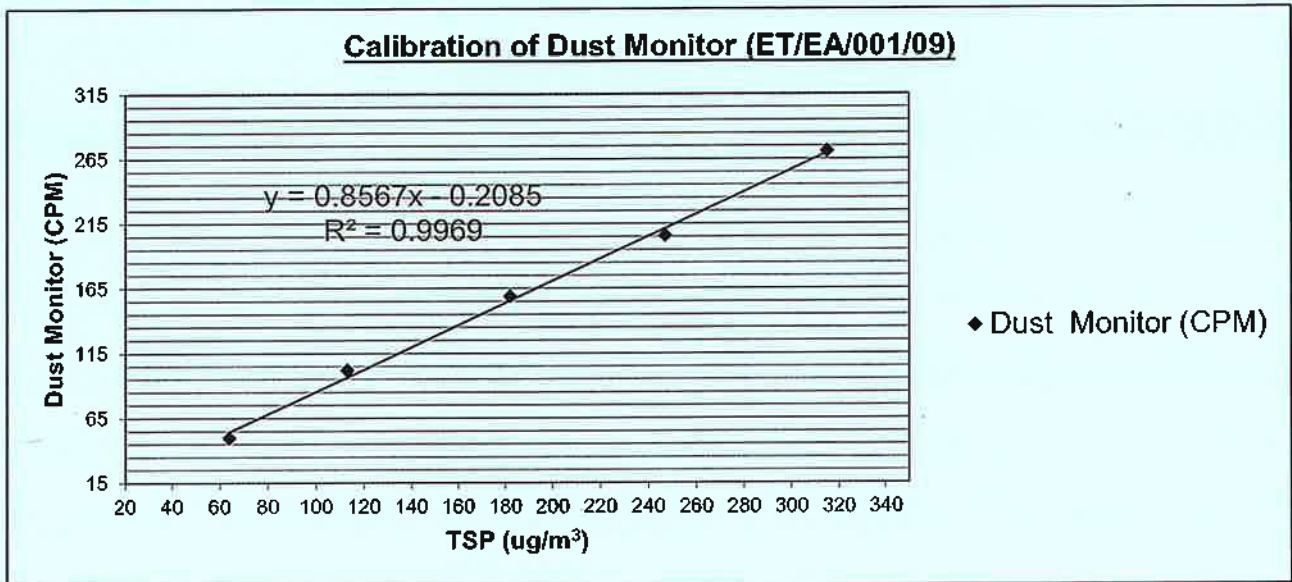

Acceptance Criteria : Correlation coefficient (r) of the calibration curve greater than 0.990 after a five-point calibration

The Dust Trak Monitor complies \* / ~~does not comply~~ \* with the internal calibration procedures and is deemed acceptable \* / unacceptable \* for use.

Calibrated by : LI, Lok Yin  
LI, Lok Yin  
(Senior Technician)

Checked by : Guy Kong Ping Ki  
Guy Kong Ping Ki  
(Laboratory Manager)



Internal Calibration Report  
of  
Dust Monitor

Manufacturer : SIBATA (LD-3B) Date of Calibration : 25 April 2022

Serial No. : 597340 (ET/EA/001/14) Calibration Due Date : 24 June 2022

Method : Parallel measurement (Five-point calibration) by placing the Dust Monitor and High Volume Air Samper together under the same environmental condition

Results	Dust Monitor (CPM)	25	57	93	142	189
	TSP ( $\mu\text{g}/\text{m}^3$ )	37	75	128	188	263
	High Volume Air Sampler Serial No.: 1174	Calibration Due Date: 07 May 2022				

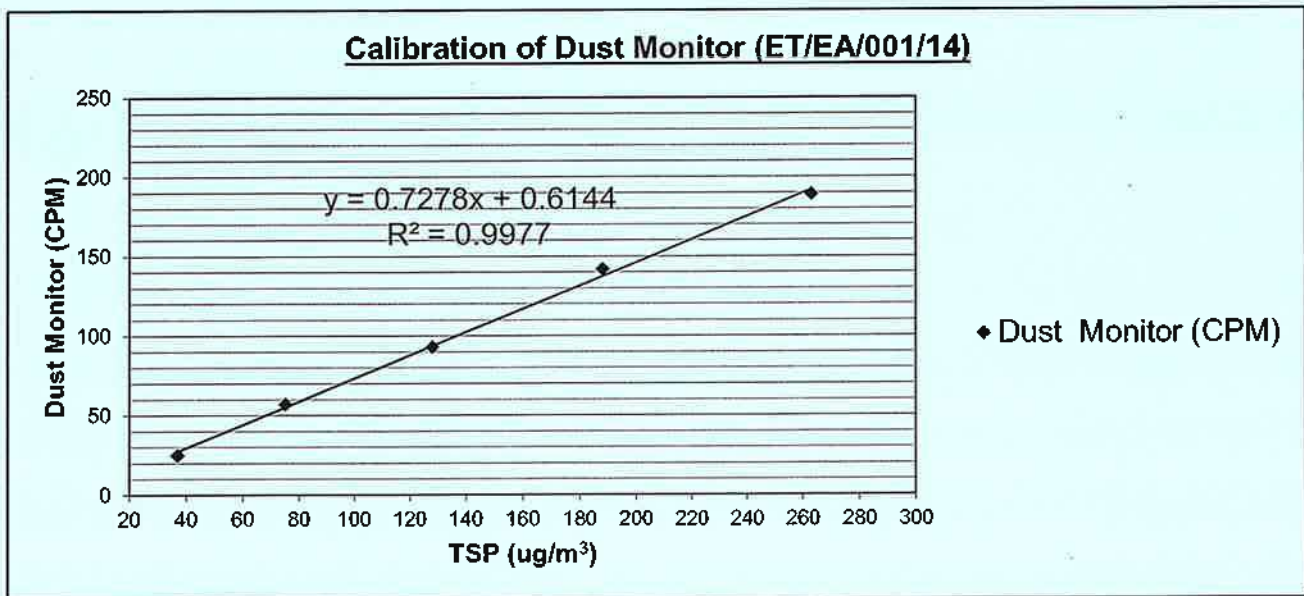

Acceptance Criteria : Correlation coefficient (r) of the calibration curve greater than 0.990 after a five-point calibration

The Dust Trak Monitor complies \* / ~~does not comply~~ \* with the internal calibration procedures and is deemed acceptable \* / ~~unacceptable~~ \* for use.

Calibrated by : LI, Lok Yin  
(Senior Technician)

Checked by : Guy, Kong Ping Ki  
(Laboratory Manager)



Internal Calibration Report  
of  
Dust Monitor

Manufacturer : SIBATA (LD-3B) Date of Calibration : 25 April 2022

Serial No. : 597227 (ET/EA/001/15) Calibration Due Date: 24 June 2022

Method : Parallel measurement (Five-point calibration) by placing the Dust Monitor and High Volume Air Samper together under the same environmental condition

Results	Dust Monitor (CPM)	22	45	75	103	144
	TSP ( $\mu\text{g}/\text{m}^3$ )	43	79	130	189	261
	High Volume Air Sampler Serial No.: 2483	Calibration Due Date: 07 May 2022				

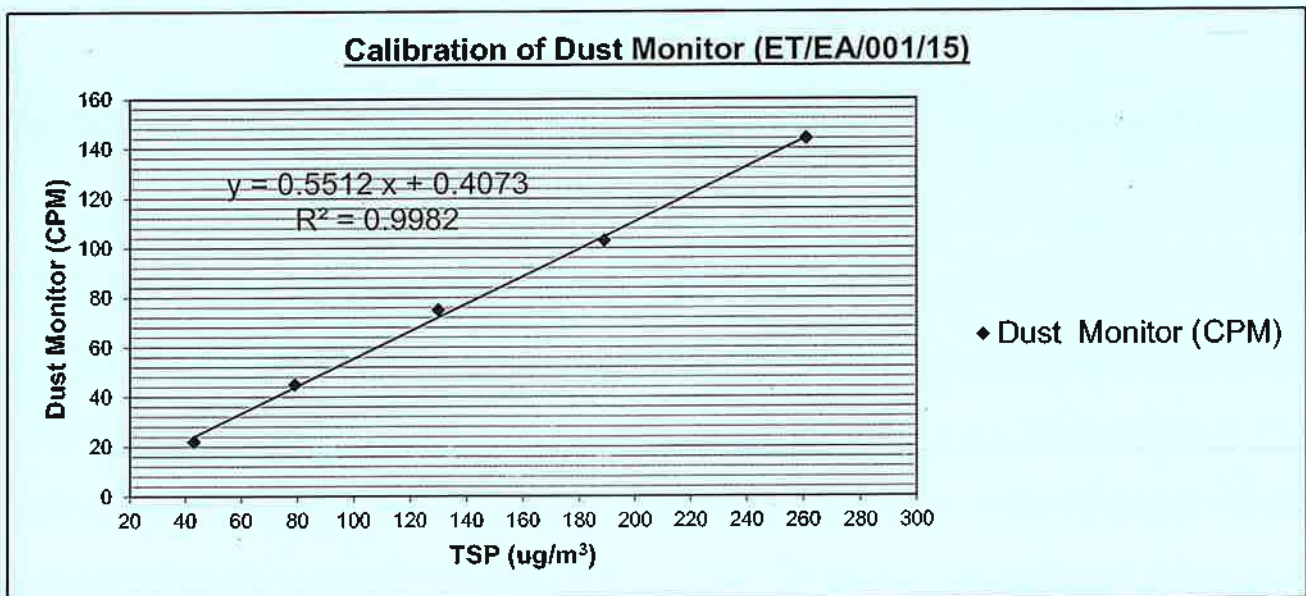

Acceptance Criteria : Correlation coefficient (r) of the calibration curve greater than 0.990 after a five-point calibration

The Dust Trak Monitor complies \* / does not comply \* with the internal calibration procedures and is deemed acceptable \* / unacceptable \* for use.

Calibrated by : LI, Lok Yin  
(Senior Technician)

Checked by : Guy, Keng Ping Ki  
(Laboratory Manager)

***Appendix 3-3***

---

*High-Volume Sampler Calibration Calculation Spreadsheet*



TEST REPORT

Calibration Report  
of  
High Volume Air Sampler

Manufacturer : Graseby GMW Date of Calibration : 08 March 2022  
Serial No. : 1180 ( ET / EA / 003 / 04 ) Calibration Due Date : 07 May 2022  
Method : Based on Operations Manual for the 5-point calibration using standard calibration kit  
manufactured by Tisch TE-5025 A

Results	Flow recorder reading (cfm)	55	51	44	35	27
	Qstd (Actual flow rate, m <sup>3</sup> /min)	1.67	1.52	1.34	1.09	0.85
	Pressure : 763.56 mm Hg	Temp. : 294 K				

Sampler 1180 Calibration Curve  
Site: Tuen Mun (TM-RA2)

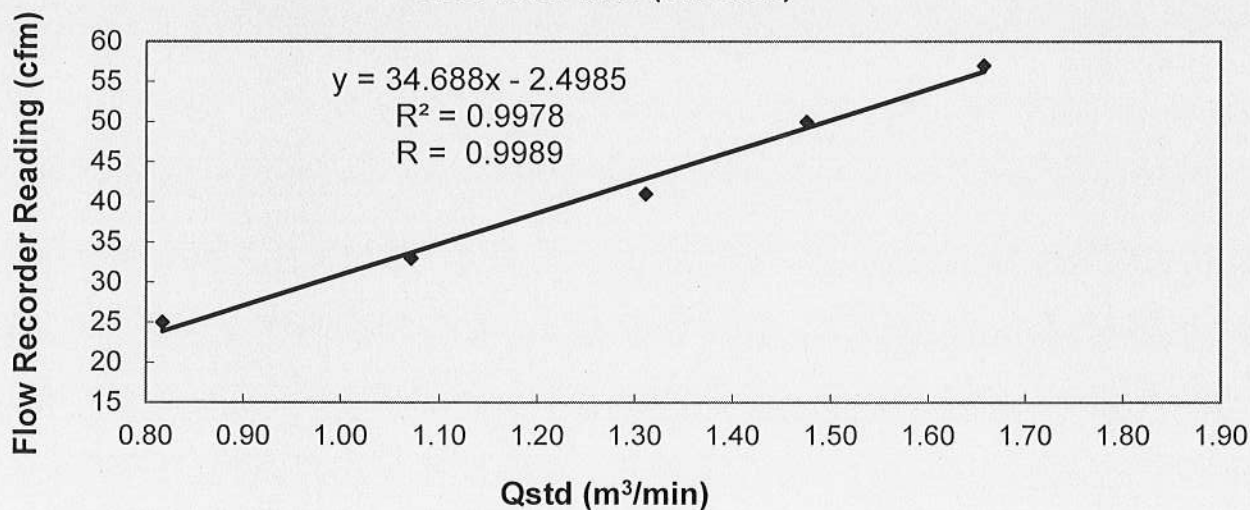

Acceptance Criteria : Correlation coefficient (r) of the calibration curve greater than 0.990 after a 5-point calibration

The high volume sampler complies\* / does not comply\* with the specified requirements and is deemed acceptable\* / unacceptable \* for use.

Calibrated by : Chan Ching-Fung  
(Technician)

Checked by : LAU, Chi Leung  
(Environmental Team Leader)



**TEST REPORT**

**Calibration Report**  
**of**  
**High Volume Air Sampler**

Manufacturer : Graseby GMW Date of Calibration : 08 March 2022

Serial No. : 1174 (ET / EA / 003 / 08) Calibration Due Date : 07 May 2022

Method : Five-point calibration by using standard calibration kit Tisch TE-5025A refer to the Operations Manual

Results :

Flow recorder reading (cfm)	58	48	41	32	26
Qstd (Actual flow rate, m <sup>3</sup> /min)	1.57	1.35	1.17	0.99	0.80
Pressure :	763.56 mm Hg		Temp. :	294 K	

**Sampler 1174 Calibration Curve**  
**Site: Tuen Mun CWSF (TM1a)**

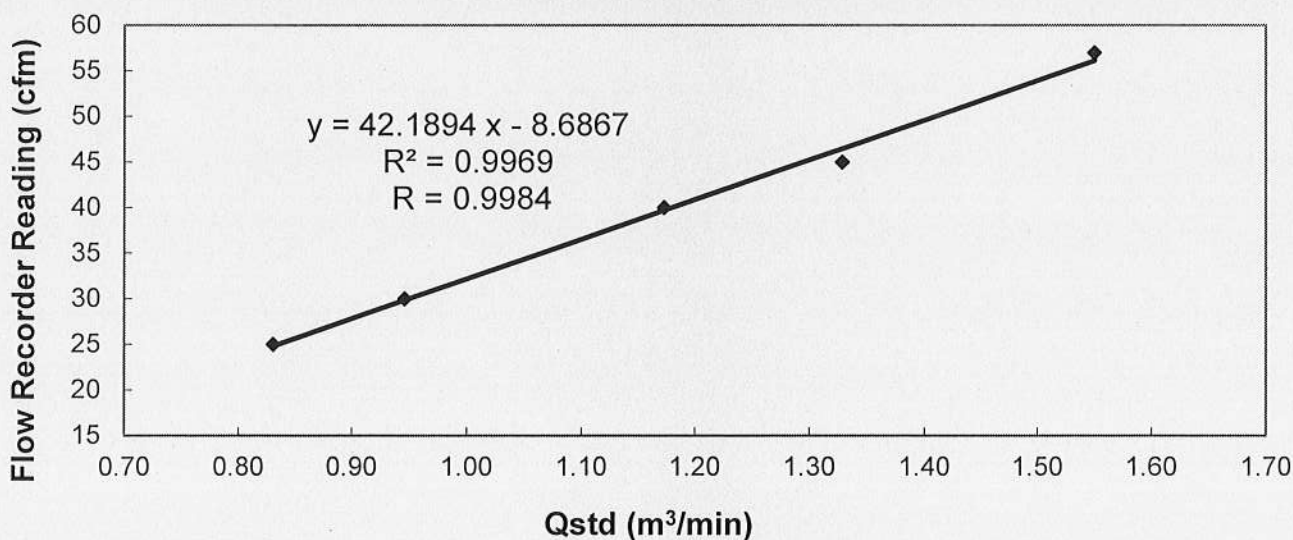

Acceptance Criteria : Correlation coefficient (r) of the calibration curve greater than 0.990 after a 5-point calibration.

The high volume sampler complies\* / does not comply\* with the specified requirements and is deemed acceptable\* / unacceptable\* for use.

Calibrated by :   
Chan Ching-Fung  
(Technician)

Checked by :   
LAU, Chi Leung  
(Environmental Team Leader)



**TEST REPORT**

Calibration Report  
of  
High Volume Air Sampler

**Manufacturer** : Graseby 105                      Date of Calibration : 09 March 2022  
**Serial No.** : 9795 ( ET / EA / 003 / 18 )                      Calibration Due Date : 08 May 2022  
**Method** : Five-point calibration by using standard calibration kit Tisch TE-5025A refer to the Operations Manual

**Results** :

Flow recorder reading (cfm)	51	46	37	32	24
Qstd (Actual flow rate, m <sup>3</sup> /min)	1.70	1.52	1.28	1.04	0.83
Pressure :	762.81 mm Hg		Temp. :	295 K	

**Sampler 9795 Calibration Curve**  
Site: Tseung Kwan O 137 (TKO-A1)

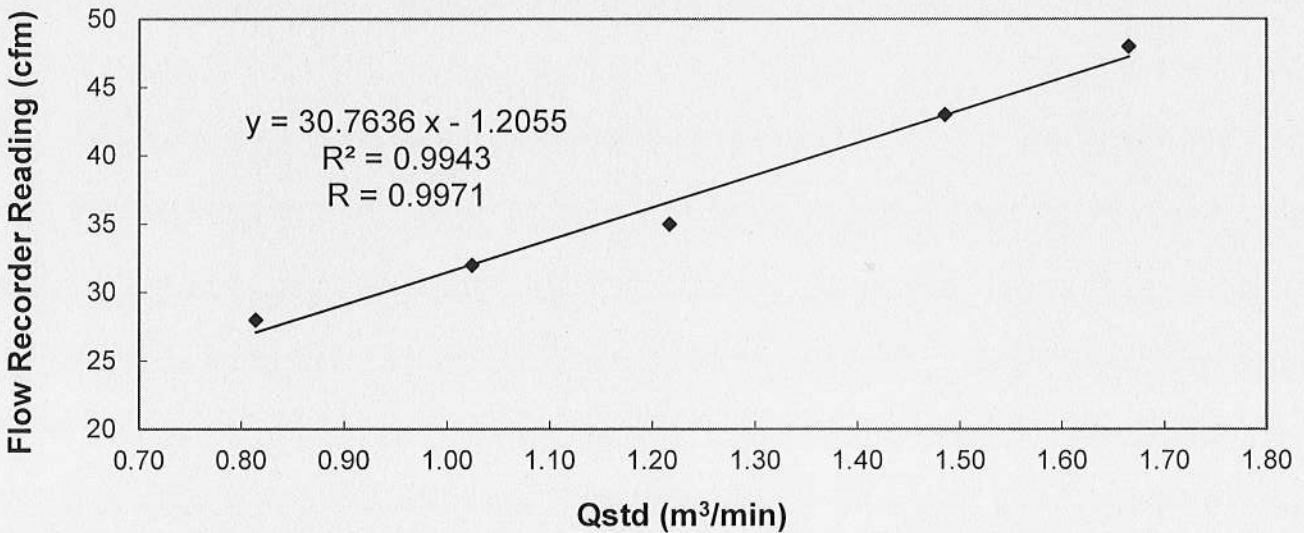

Acceptance Criteria : Correlation coefficient (r) of the calibration curve greater than 0.990 after a 5-point calibration

The high volume sampler complies\* / ~~does not comply\*~~ with the specified requirements and is deemed acceptable\* / unacceptable\* for use.

Calibrated by :   
Chan Ching-Fung  
(Technician)

Checked by :   
LAU, Chi Leung  
(Environmental Team Leader)





**TEST REPORT**

**Calibration Report  
of  
High Volume Air Sampler**

**Manufacturer** : Graseby GMW                      Date of Calibration : 08 March 2022  
**Serial No.** : 2483 (ET / EA / 003 / 26)                      Calibration Due Date : 07 May 2022  
**Method** : Five-point calibration by using standard calibration kit Tisch TE-5025A refer to the Operations Manual

<b>Results</b>	Flow recorder reading (cfm)	55	47	41	34	30
	Qstd (Actual flow rate, m <sup>3</sup> /min)	1.59	1.33	1.17	0.93	0.77
	Pressure :                      763.56 mm Hg	Temp. :                      294 K				

**Sampler 2483 Calibration Curve  
Site: Tuen Mun CWSF (TM2)**

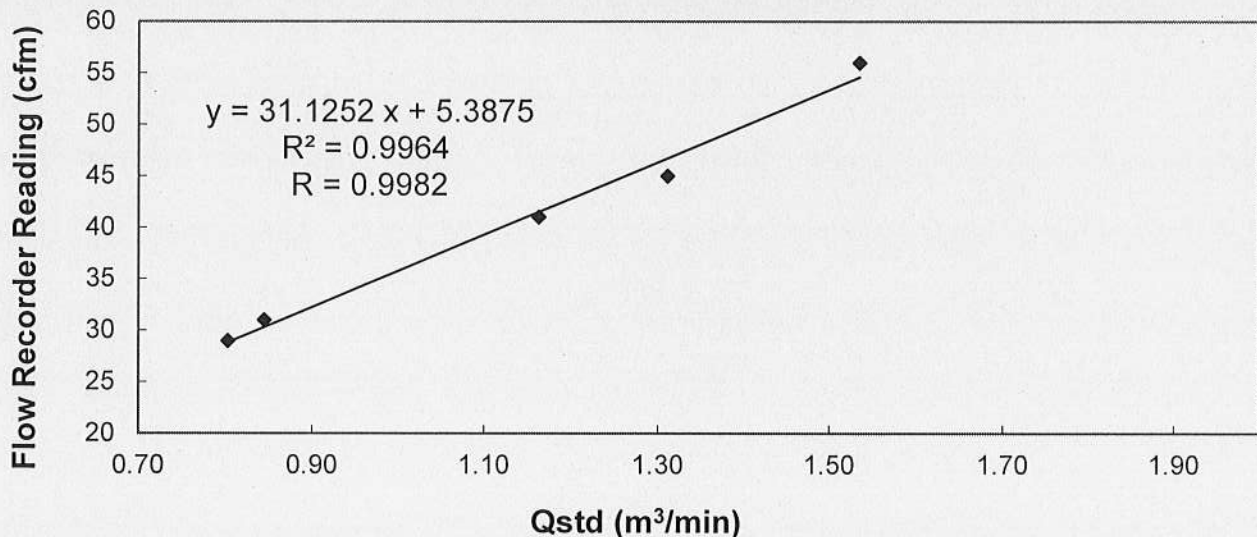

Acceptance Criteria : Correlation coefficient (r) of the calibration curve greater than 0.990 after a 5-point calibration

The high volume sampler complies\* / does not comply\* with the specified requirements and is deemed acceptable\* / unacceptable\* for use.

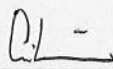
Calibrated by :   
Chan Ching-Fung  
(Technician)

Checked by :   
LAU, Chi Leung  
(Environmental Team Leader)

# Certificate of Calibration

Calibration Certification Information			
Cal. Date: January 11, 2021	Rootsmeter S/N: 438320	Ta: 297	°K
Operator: Jim Tisch		Pa: 750.1	mm Hg
Calibration Model #: TE-5025A	Calibrator S/N: <b>3863</b>		

Run	Vol. Init (m3)	Vol. Final (m3)	ΔVol. (m3)	ΔTime (min)	ΔP (mm Hg)	ΔH (in H2O)
1	1	2	1	1.4540	3.2	2.00
2	3	4	1	1.0210	6.4	4.00
3	5	6	1	0.9090	8.0	5.00
4	7	8	1	0.8700	8.8	5.50
5	9	10	1	0.7190	12.8	8.00

Data Tabulation					
Vstd (m3)	Qstd (x-axis)	$\sqrt{\Delta H \left( \frac{Pa}{Pstd} \right) \left( \frac{Tstd}{Ta} \right)}$ (y-axis)	Va	Qa (x-axis)	$\sqrt{\Delta H \left( Ta/Pa \right)}$ (y-axis)
0.9860	0.6781	1.4073	0.9957	0.6848	0.8899
0.9818	0.9616	1.9902	0.9915	0.9711	1.2585
0.9797	1.0778	2.2251	0.9893	1.0884	1.4071
0.9786	1.1249	2.3337	0.9883	1.1359	1.4757
0.9733	1.3538	2.8146	0.9829	1.3671	1.7798
<b>QSTD</b>	m=	<b>2.08168</b>	<b>QA</b>	m=	<b>1.30351</b>
	b=	<b>-0.00913</b>		b=	<b>-0.00577</b>
	r=	<b>0.99993</b>		r=	<b>0.99993</b>

Calculations	
$Vstd = \Delta Vol \left( \frac{Pa - \Delta P}{Pstd} \right) \left( \frac{Tstd}{Ta} \right)$	$Va = \Delta Vol \left( \frac{Pa - \Delta P}{Pa} \right)$
$Qstd = Vstd / \Delta Time$	$Qa = Va / \Delta Time$
For subsequent flow rate calculations:	
$Qstd = 1/m \left( \left( \sqrt{\Delta H \left( \frac{Pa}{Pstd} \right) \left( \frac{Tstd}{Ta} \right)} \right) - b \right)$	$Qa = 1/m \left( \left( \sqrt{\Delta H \left( Ta/Pa \right)} \right) - b \right)$

Standard Conditions	
Tstd:	298.15 °K
Pstd:	760 mm Hg
Key	
ΔH:	calibrator manometer reading (in H2O)
ΔP:	rootsmeter manometer reading (mm Hg)
Ta:	actual absolute temperature (°K)
Pa:	actual barometric pressure (mm Hg)
b:	intercept
m:	slope

RECALIBRATION
US EPA recommends annual recalibration per 1998 40 Code of Federal Regulations Part 50 to 51, Appendix B to Part 50, Reference Method for the Determination of Suspended Particulate Matter in the Atmosphere, 9.2.17, page 30

***Appendix 3-4***

---

*Methodology for Correlation Calculation between Potable Laser Dust Meter and High-Volume Sampler*

# **1. Correlation between Portable laser dusty meter and High-volume Sampler Methodology**

## **1.1. Correlation results between the direct reading meter and High-Volume Sampler**

### High – Volume Sampler Calibration

- 1.1.1. The specification, a sample of calibration certificate and certificate of comparison check with High volume sampler of the proposed air quality monitoring equipment listed in Table 2.1 are attached in appendix.
- 1.1.2. The High-Volume air sampler calibration procedure based on the requirement of manufacturer are shown below.
  - (a) Disconnect the sampler motor from the mass flow controller and connect the motor to a stable AC power source.
  - (b) Mount the calibrator orifice and top loading adapter plate to the sampler. A sampling filter is generally not used during this procedure. Tighten the top loading adapter hold down nuts securely to ensure that no air leaks are present.
  - (c) Allow the sampler motor to warm up to its normal operating temperature
  - (d) (approximately 10-15 minutes).
  - (e) Conduct a leak test by covering the hole(s) on top of the orifice and pressure tap on the orifice with your hands. Listen for a high-pitched squealing sound made by escaping air. If this sound is heard, a leak is present and the top loading adapter hold-down nuts need to be re-tightened. If the sound is lower, the leak is near one of the other gaskets in the system. Avoid running the sampler for longer than 30 seconds at a time with the orifice blocked to avoid overheating the motor. Do not perform this leak test procedure with a manometer connected to the side tap on the calibration orifice or the blower motor. Liquid from the manometer could be drawn into the system and cause motor damage.
  - (f) Connect one side of a water manometer to the pressure tap on the side of the orifice with a rubber vacuum tube. Leave the opposite side of the manometer open to the atmosphere. Note: Both valves on the manometer have to be open for the liquid to flow

freely. One side of the 'U' tube goes up the other goes down; add together for the "H2O reading.

- (g) A manometer must be held vertically to ensure accurate readings. Tapping the backside of the continuous flow recorder will help to center the pen and provide accurate readings. When using a variable orifice , five flow rates are achieved in this step by adjusting the knob on the variable orifice to five different positions and taking five different readings.
- (h) Record the ambient air temperature, the ambient barometric pressure, the sampler serial number, the orifice s/n, the orifice slope and intercept with date last certified, todays date, site location and the operators initials on the attached blank calibration sheet.
- (i) An example of a Lead (or TSP) Sampler Calibration Data Sheet has been attached with data filled in from a typical calibration. This includes the transfer standard orifice calibration relationship which was taken from the Orifice Calibration Worksheet that accompanies the calibrator orifice.

Disconnect the sampler motor from its power source and remove the orifice and top loading adapter plate. Re-connect the sampler motor to the electronic mass flow controller.

1.1.3. Since this calibration is for a TSP sampler, the slope and intercept for this orifice uses standard flows rather than actual flows and is taken from the  $Q^{\text{standard}}$  section of the Orifice Calibration Worksheet. The  $Q^{\text{actual}}$  flows are only used when calibrating a PM-10 sampler.

2.3.4 The five orifice manometer readings taken during the calibration have been recorded in the column on the data worksheet titled Orifice "H2O. The five continuous flow recorder readings taken during the calibration have been recorded under the column titled I chart.

- 2.3.5 The orifice manometer readings need to be converted to the standard air flows they represent using the following equation:

$$Q_{std} = 1/m[\text{Sqrt}((H_2O)(Pa/760)(298/Ta))-b]$$

*where:*

$Q_{std}$  = actual flow rate as indicated by the calibrator orifice, m<sup>3</sup>/min

$H_2O$  = orifice manometer reading during calibration, "H<sub>2</sub>O

$T_a$  = ambient temperature during calibration, K ( K = 273 + °C)

298 = standard temperature, a constant that never changes, K

$P_a$  = ambient barometric pressure during calibration, mm Hg

760 = standard barometric pressure, a constant that never changes, mm Hg

$m$  = *Q*standard slope of orifice calibration relationship

$b$  = *Q*standard intercept of orifice calibration relationship.

- 2.3.6 Once these standard flow rates have been determined for each of the five run points, they are recorded in the column titled  $Q_{std}$ , and are represented in cubic meters per minute.
- 2.3.7 Once these standard flow rates have been determined for each of the five run points, they are recorded in the column titled  $Q_{std}$ , and are represented in cubic meters per minute

2.3.8 The continuous flow recorder readings taken during the calibration need to be corrected to the current meteorological conditions using the following equation:

$$IC = I[\text{Sqrt}((Pa/760)(298/Ta))]$$

*where:*

IC = continuous flow recorder readings corrected to current Ta and Pa

I = continuous flow recorder readings during calibration

Pa = ambient barometric pressure during calibration, mm Hg.

760 = standard barometric pressure, a constant that never changes, mm Hg

Ta = ambient temperature during calibration, K ( K = 273 + °C)

298 = standard temperature, a constant that never changes, K

2.3.9 After each of the continuous flow recorder readings have been corrected, they are recorded in the column titled IC (corrected).

2.3.10 Using Qstd and IC (or FLOW (corrected)) as the x and y axis respectively, a slope, intercept, and correlation coefficient can be calculated using the least squares regression method. The correlation coefficient should never be less than 0.990 after a five-point calibration. A coefficient below .990 indicates a calibration that is not linear and the calibration should be performed again. If this occurs, it is most likely the result of an air leak during the calibration or high wind speed during the calibration procedure.

2.3.11 The equations for determining the slope (m) and intercept (b) are as follows:

$$m = \frac{(\sum x)(\sum y) - \sum xy - n}{(\sum x)^2 - \sum x^2 - n} ; \quad b = \bar{y} - m\bar{x}$$

The equation for the coefficient of correlation (r) is as follows:

$$r = \frac{\sum xy - \frac{(\sum x)(\sum y)}{n}}{\sqrt{\left[ \sum x^2 - \frac{(\sum x)^2}{n} \right] \left[ \sum y^2 - \frac{(\sum y)^2}{n} \right]}}$$

where:  $n$  = number of observations  
 $\sum$  = sum of

- 2.3.12 The acceptable operating flow range of a TSP sampler is 1.1 to 1.7 m<sup>3</sup>/min (39 to 60 CFM). Looking at the worksheet column Qstd(see page 38), the flow rates that are within this range can be identified along with the chart reading (I) that represents them. For instance, if you wanted to set this sampler at 1.265 m<sup>3</sup>/min (44.67 CFM) (Make sure the mass flow controller is plugged in and a filter is in place) you would turn the Flow Adjustment screw until the continuous flow recorder read 37 on the chart. By making sure that the sampler is operating at a chart reading (or manometer reading) that is within the acceptable range, it can be assumed that valid TSP data is being collected.
- 2.3.13 A calibration that has a correlation coefficient of less than .990 is not considered linear and should be re-calibrated. Therefore, if  $r < 0.990$ , return all the points or only the point with the greatest deviation and the recalculate.
- 2.3.14 The 24-hour TSP levels to be measured by direct reading methods, utilising portable Laser Particle Photometer Monitors (Sibata Model LD-3B), in place of High-Volume Sampler (HVS) if HVS experience difficulties in operation during monitoring. It is demonstrated by the previous project experiences, that 24-hour TSP monitoring results collected by direct reading method are comparable to those produced by the high-volume sampling method, to indicate short event impacts. The projects utilising the collection of 24-hour TSP levels data by direct reading methods are shown below.



***Project Reference for utilising the collection of 24-hour TSP levels data by direct reading methods***

<b>Project Contract Number</b>	<b>Location</b>	<b>Status</b>
NDO 03/2018	Road Widening and Retrofitting Noise Barriers on Tai Po Road (Sha Tin Section)	On-going
NDO 14/2018	Advance and First Stage Works of Kwu Tung North and Fanling North New Development Areas	On-going

2.3.15 Calculation of the value of 24-hour TSP concentration is given by the average of 24 calculated 1-hour TSP concentration, where the calculated 1-hr TSP concentration is given by the product of the direct reading and the K-factor based on the correlation results between the direct reading meter and High-Volume Sampler.

2.3.16 The correlation results between the direct reading meter and High-Volume Sampler shall be review with bimonthly internal calibration. To maintain the correlation with two sets of data (monitoring data from HVS and monitoring data from Portable Laser Particle Photometer Monitors) bimonthly internal calculated are strongly linked together two sets of data.

2.3.17 To protect the dust meter from being damaged and to operate without disturbances or nuisance, temporary barriers shall be erected around the monitoring equipment during the monitoring period. Temporary barriers will be placed approx. 0.5m away from the dust meter.

**Maintenance/ Calibration for the High-Volume Sampler (HVS) being correlation**

2.3.18 The HVS shall be calibrated bimonthly in accordance to the specification in the manufacturer's manual. The calibration certificates shall be available to the IEC for checking upon request. The validity and accuracy of the HVS shall also be tested against the result by the TE-5025A Calibration Kit periodically, Details of Calibration Cert and Specification for HVS – Graseby GMW and HVS- Calibration Kit TE-5025A are given in Appendix 2-1 and Appendix 2-3.

2.3.19 Graseby GMW is chosen as the HVS for 24-hour TSP monitoring and Tisch TE – 5025A is chosen as the HVS Calibration-Kit for HVS calibration.

2.3.20 The high-volume motors and their accessories should be properly maintained. Appropriate maintenance such as routine motor brushes replacement and electrical wiring checking should be made to ensure that the equipment and necessary power supply were in good working condition.

***Appendix 3-5***

---

*Correlation Calculation between Potable Laser Dust Meter and High-Volume  
Sampler*



**Internal Calibration Report**  
of  
**Dust Monitor**

Manufacturer : SIBATA (LD-3B) Date of Calibration : 25 April 2022

Serial No. : 014746 (ET/EA/001/06) Calibration Due Date : 24 June 2022

Method : Parallel measurement (Five-point calibration) by placing the Dust Monitor and High Volume Air Sampler together under the same environmental condition

Results	Dust Monitor (CPM)	25	50	77	134	178
	TSP ( $\mu\text{g}/\text{m}^3$ )	46	92	139	227	315
High Volume Air Sampler Serial No.: 1180		Calibration Due Date: 07 May 2022				

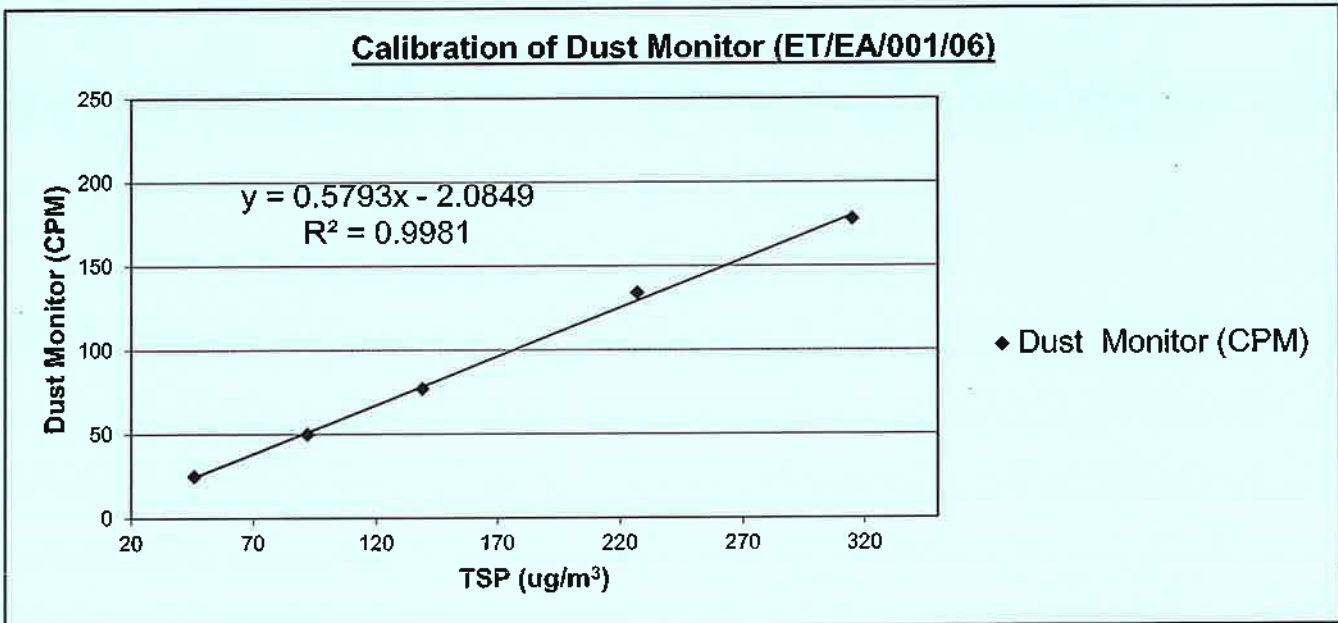

Acceptance Criteria : Correlation coefficient (r) of the calibration curve greater than 0.990 after five-point calibration.

The Dust Trak Monitor complies \* / ~~does not comply~~ \* with the internal calibration procedures and is deemed acceptable \* / ~~unacceptable~~ \* for use.

Calibrated by :   
LI, Lok Yin  
(Senior Technician)

Checked by :   
Guy, Kong Ping Ki  
(Laboratory Manager)



**Internal Calibration Report**  
of  
**Dust Monitor**

Manufacturer : SIBATA (LD-3B) Date of Calibration : 25 April 2022

Serial No. : 155331 (ET/EA/001/09) Calibration Due Date : 24 June 2022

Method : Parallel measurement (Five-point calibration) by placing the Dust Monitor and High Volume Air Sampler together under the same environmental condition

Results : Dust Monitor (CPM)	50	102	159	206	271
TSP (ug/m <sup>3</sup> )	64	113	182	247	315
High Volume Air Sampler Serial No.: 9795	Calibration Due Date: 08 May 2022				

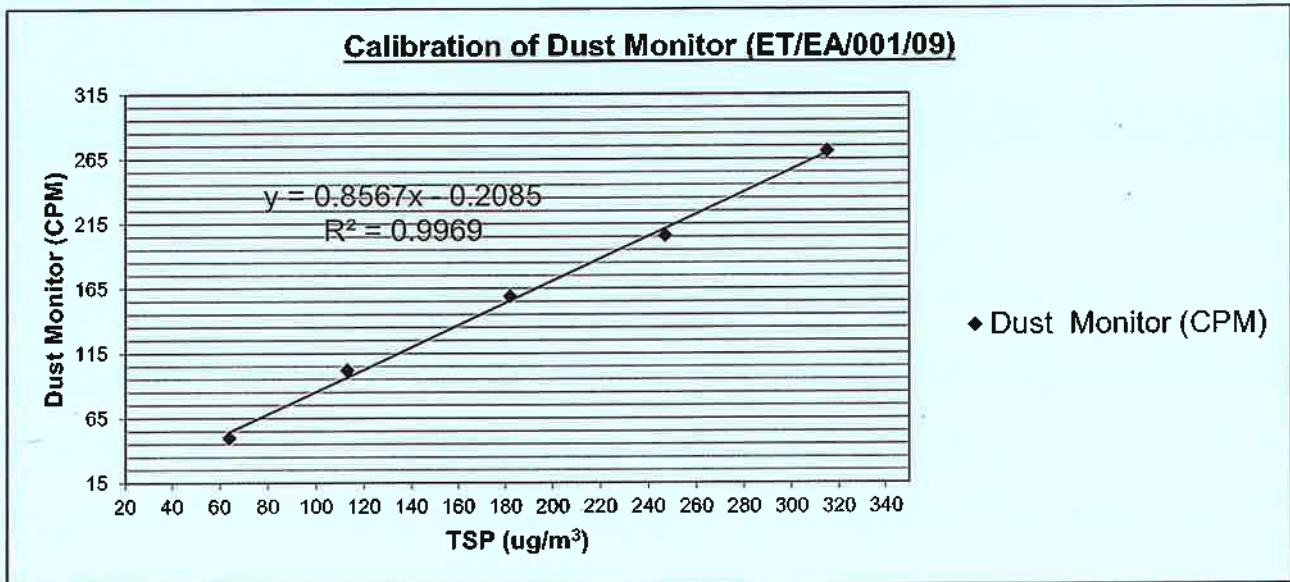

Acceptance Criteria : Correlation coefficient (r) of the calibration curve greater than 0.990 after a five-point calibration

The Dust Trak Monitor complies \* / ~~does not comply~~ \* with the internal calibration procedures and is deemed acceptable \* / unacceptable \* for use.

Calibrated by : LI, Lok Yin  
LI, Lok Yin  
(Senior Technician)

Checked by : Guy Kong Ping Ki  
Guy Kong Ping Ki  
(Laboratory Manager)



Internal Calibration Report  
of  
Dust Monitor

Manufacturer : SIBATA (LD-3B) Date of Calibration : 25 April 2022

Serial No. : 597340 (ET/EA/001/14) Calibration Due Date : 24 June 2022

Method : Parallel measurement (Five-point calibration) by placing the Dust Monitor and High Volume Air Samper together under the same environmental condition

Results	Dust Monitor (CPM)	25	57	93	142	189
	TSP (ug/m <sup>3</sup> )	37	75	128	188	263
	High Volume Air Sampler Serial No.: 1174	Calibration Due Date: 07 May 2022				

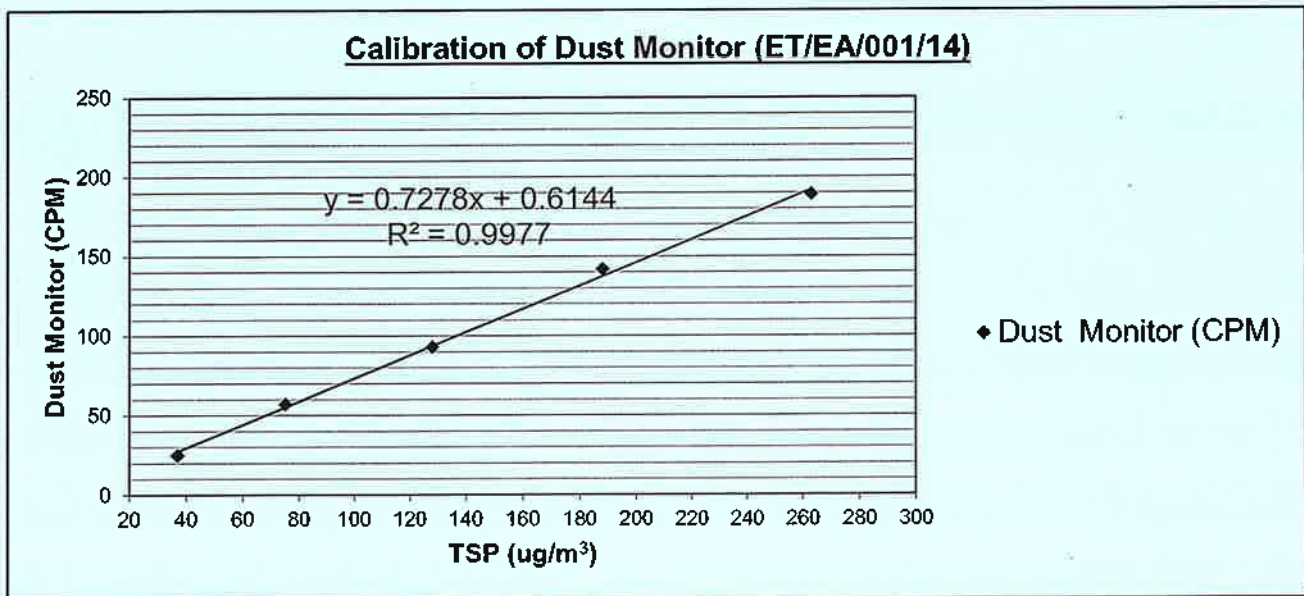

Acceptance Criteria : Correlation coefficient (r) of the calibration curve greater than 0.990 after a five-point calibration

The Dust Trak Monitor complies \* / ~~does not comply~~ \* with the internal calibration procedures and is deemed acceptable \* / ~~unacceptable~~ \* for use.

Calibrated by : LI, Lok Yin  
(Senior Technician)

Checked by : Guy, Kong Ping Ki  
(Laboratory Manager)



Internal Calibration Report  
of  
Dust Monitor

Manufacturer : SIBATA (LD-3B) Date of Calibration : 25 April 2022

Serial No. : 597227 (ET/EA/001/15) Calibration Due Date: 24 June 2022

Method : Parallel measurement (Five-point calibration) by placing the Dust Monitor and High Volume Air Samper together under the same environmental condition

Results	Dust Monitor (CPM)	22	45	75	103	144
	TSP (ug/m <sup>3</sup> )	43	79	130	189	261
	High Volume Air Sampler Serial No.: 2483	Calibration Due Date: 07 May 2022				

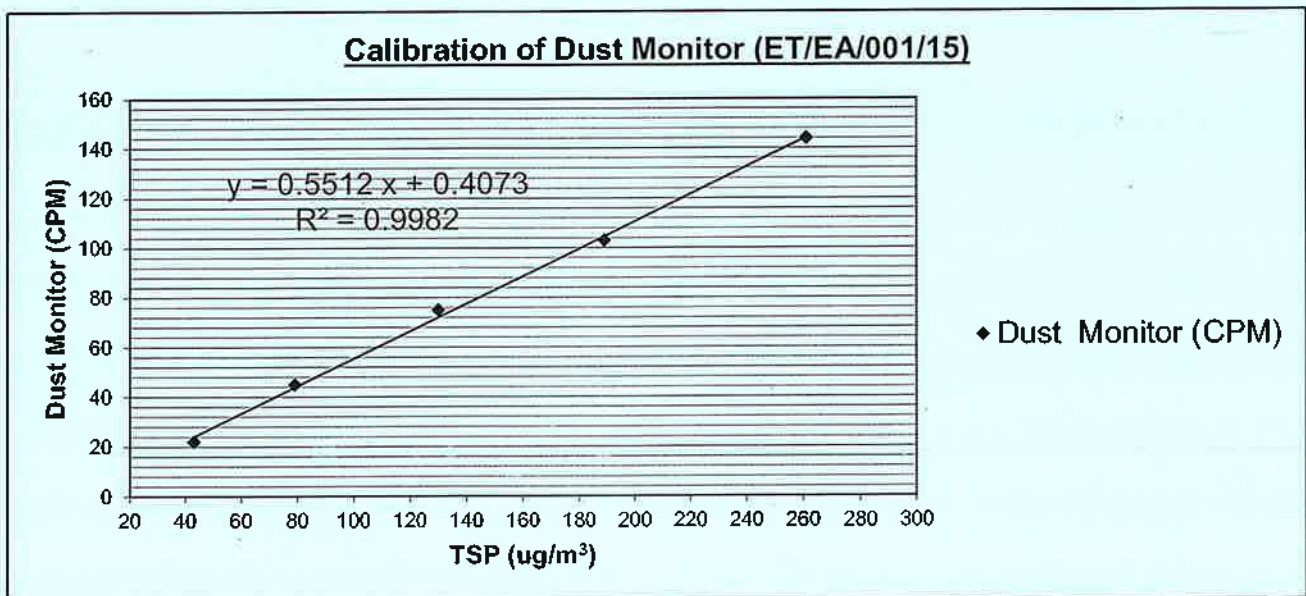

Acceptance Criteria : Correlation coefficient (r) of the calibration curve greater than 0.990 after a five-point calibration

The Dust Trak Monitor complies \* / does not comply \* with the internal calibration procedures and is deemed acceptable \* / unacceptable \* for use.

Calibrated by : LI, Lok Yin  
(Senior Technician)

Checked by : Guy, Keng Ping Ki  
(Laboratory Manager)

***Appendix 3-6***

---

*Air Quality and Noise Impact Monitoring Schedule*

**Contract No. EP516/2016  
Port Shelter Sewerage, stage 3 – Sewage Works at Po Toi O**

**2022/05 Air and Noise Quality Impact Monitoring Schedule**

<i>Sunday</i>	<i>Monday</i>	<i>Tuesday</i>	<i>Wednesday</i>	<i>Thursday</i>	<i>Friday</i>	<i>Saturday</i>
<b>1-May</b>	<b>2-May</b>	<b>3-May</b>	<b>4-May</b>	<b>5-May</b>	<b>6-May</b>	<b>7-May</b>
				*Noise ** 1 - hr TSP **24- hr TSP		
<b>8-May</b>	<b>9-May</b>	<b>10-May</b>	<b>11-May</b>	<b>12-May</b>	<b>13-May</b>	<b>14-May</b>
			*Noise ** 1 - hr TSP **24- hr TSP			
<b>15-May</b>	<b>16-May</b>	<b>17-May</b>	<b>18-May</b>	<b>19-May</b>	<b>20-May</b>	<b>21-May</b>
		*Noise ** 1 - hr TSP **24- hr TSP				
<b>22-May</b>	<b>23-May</b>	<b>24-May</b>	<b>25-May</b>	<b>26-May</b>	<b>27-May</b>	<b>28-May</b>
	*Noise ** 1 - hr TSP **24- hr TSP					** 1 - hr TSP **24- hr TSP
<b>29-May</b>	<b>30-May</b>	<b>31-May</b>	<b>1-Jun</b>	<b>2-Jun</b>	<b>3-Jun</b>	<b>4-Jun</b>

\* Noise Monitoring Locations: NSM1N,NMS2N,NMS3N and NMS4N

\*\* 1hr TSP and 24- hr TSP Monitoring Locations: ASM1N ,ASM2N1, ASN3N and ASM4N



**Contract No. EP516/2016  
Port Shelter Sewerage, stage 3 – Sewage Works at Po Toi O**

**2022/06 Air and Noise Quality Impact Monitoring Schedule**

<i>Sunday</i>	<i>Monday</i>	<i>Tuesday</i>	<i>Wednesday</i>	<i>Thursday</i>	<i>Friday</i>	<i>Saturday</i>
<b>29-May</b>	<b>30-May</b>	<b>31-May</b>	<b>1-Jun</b>	<b>2-Jun</b>	<b>3-Jun</b>	<b>4-Jun</b>
				*Noise ** 1 - hr TSP **24- hr TSP		
<b>5-Jun</b>	<b>6-Jun</b>	<b>7-Jun</b>	<b>8-Jun</b>	<b>9-Jun</b>	<b>10-Jun</b>	<b>11-Jun</b>
			*Noise ** 1 - hr TSP **24- hr TSP			
<b>12-Jun</b>	<b>13-Jun</b>	<b>14-Jun</b>	<b>15-Jun</b>	<b>16-Jun</b>	<b>17-Jun</b>	<b>18-Jun</b>
		*Noise ** 1 - hr TSP **24- hr TSP				
<b>19-Jun</b>	<b>20-Jun</b>	<b>21-Jun</b>	<b>22-Jun</b>	<b>23-Jun</b>	<b>24-Jun</b>	<b>25-Jun</b>
	*Noise ** 1 - hr TSP **24- hr TSP					** 1 - hr TSP **24- hr TSP
<b>26-Jun</b>	<b>27-Jun</b>	<b>28-Jun</b>	<b>29-Jun</b>	<b>30-Jun</b>	<b>1-Jul</b>	<b>2-Jul</b>
				*Noise ** 1 - hr TSP **24- hr TSP		

\* Noise Monitoring Locations: NSM1N,NMS2N,NMS3N and NMS4N

\*\* 1hr TSP and 24- hr TSP Monitoring Locations: ASM1N ,ASM2N1, ASN3N and ASM4N

***Appendix 3-7***

---

*1 hr and 24 hrs TSP Monitoring Result*

Project No. 1825

Monthly Environmental Monitoring & Audit Report for Port Shelter Phase 3, Po Toi O Sewerage Treatment Plant

2022/05 1-hour and 24-hours TSP Monitoring Data

Monitoring Location : AMS-1N

Date	Weather	1-hour TSP Monitoring			24-hour TSP Monitoring		
			Start Time	Concentration ( $\mu\text{g}/\text{m}^3$ )	Average Concentration ( $\mu\text{g}/\text{m}^3$ )	Start Time	Concentration ( $\mu\text{g}/\text{m}^3$ )
2022-05-05	Fine	1st hr	08:29	46.0	42.0	08:29	42.0
		2nd hr	09:29	38.0			
		3rd hr	10:29	42.0			
2022-05-11	Cloudy	1st hr	08:55	77.0	77.7	08:55	78.0
		2nd hr	09:55	81.0			
		3rd hr	10:55	75.0			
2022-05-17	Fine	1st hr	13:03	16.0	18.3	13:03	18.0
		2nd hr	14:03	16.0			
		3rd hr	15:03	23.0			
2022-05-23	Cloudy	1st hr	08:24	43.0	38.0	08:24	38.0
		2nd hr	09:24	39.0			
		3rd hr	10:24	32.0			
2022-05-28	Fine	1st hr	09:13	32.0	32.7	09:13	33.0
		2nd hr	10:13	32.0			
		3rd hr	11:13	34.0			
				Average :	41.7	Average :	41.8
				Action Level :	319	Action Level :	153
				Limit Level :	500	Limit Level :	260

Project No. 1825

Monthly Environmental Monitoring & Audit Report for Port Shelter Phase 3, Po Toi O Sewerage Treatment Plant

2022/05 1-hour and 24-hours TSP Monitoring Data

Monitoring Location :

AMS-2N1

Date	Weather	1-hour TSP Monitoring			24-hour TSP Monitoring		
			Start Time	Concentration ( $\mu\text{g}/\text{m}^3$ )	Average Concentration ( $\mu\text{g}/\text{m}^3$ )	Start Time	Concentration ( $\mu\text{g}/\text{m}^3$ )
2022-05-05	Fine	1st hr	13:00	40.0	35.3	13:00	35.0
		2nd hr	14:00	32.0			
		3rd hr	15:00	34.0			
2022-05-11	Cloudy	1st hr	09:00	39.0	40.0	09:00	40.0
		2nd hr	10:00	38.0			
		3rd hr	11:00	43.0			
2022-05-17	Fine	1st hr	13:00	23.0	23.3	13:00	23.0
		2nd hr	14:00	20.0			
		3rd hr	15:00	27.0			
2022-05-23	Cloudy	1st hr	13:04	28.0	28.3	13:04	28.0
		2nd hr	14:04	28.0			
		3rd hr	15:04	29.0			
2022-05-28	Fine	1st hr	08:22	34.0	30.7	08:22	31.0
		2nd hr	09:22	31.0			
		3rd hr	10:22	27.0			
Average :				31.5	Average :		31.4
Action Level :				279	Action Level :		179
Limit Level :				500	Limit Level :		260

Project No. 1825

Monthly Environmental Monitoring & Audit Report for Port Shelter Phase 3, Po Toi O Sewerage Treatment Plant

2022/05 1-hour and 24-hours TSP Monitoring Data

Monitoring Location : AMS-3N

Date	Weather	1-hour TSP Monitoring			24-hour TSP Monitoring		
			Start Time	Concentration ( $\mu\text{g}/\text{m}^3$ )	Average Concentration ( $\mu\text{g}/\text{m}^3$ )	Start Time	Concentration ( $\mu\text{g}/\text{m}^3$ )
2022-05-05	Fine	1st hr	08:35	45.0	39.3	08:35	39.0
		2nd hr	09:35	39.0			
		3rd hr	10:35	34.0			
2022-05-11	Cloudy	1st hr	13:06	66.0	63.0	13:06	63.0
		2nd hr	14:06	60.0			
		3rd hr	15:06	63.0			
2022-05-17	Fine	1st hr	08:26	29.0	24.3	08:26	24.0
		2nd hr	09:26	23.0			
		3rd hr	10:26	21.0			
2022-05-23	Cloudy	1st hr	13:00	25.0	25.7	13:00	26.0
		2nd hr	14:00	25.0			
		3rd hr	15:00	27.0			
2022-05-28	Fine	1st hr	08:28	36.0	26.7	08:28	27.0
		2nd hr	09:28	23.0			
		3rd hr	10:28	21.0			
				Average :	35.8	Average :	35.8
				Action Level :	303	Action Level :	158
				Limit Level :	500	Limit Level :	260

Project No. 1825

Monthly Environmental Monitoring & Audit Report for Port Shelter Phase 3, Po Toi O Sewerage Treatment Plant

2022/05 1-hour and 24-hours TSP Monitoring Data

Monitoring Location :

AMS-4N

Date	Weather	1-hour TSP Monitoring			24-hour TSP Monitoring		
			Start Time	Concentration ( $\mu\text{g}/\text{m}^3$ )	Average Concentration ( $\mu\text{g}/\text{m}^3$ )	Start Time	Concentration ( $\mu\text{g}/\text{m}^3$ )
2022-05-05	Fine	1st hr	13:05	28.0	25.0	13:05	25.0
		2nd hr	14:05	21.0			
		3rd hr	15:05	26.0			
2022-05-11	Cloudy	1st hr	13:00	72.0	69.0	13:00	69.0
		2nd hr	14:00	70.0			
		3rd hr	15:00	65.0			
2022-05-17	Fine	1st hr	08:34	31.0	26.0	08:34	26.0
		2nd hr	09:34	24.0			
		3rd hr	10:34	23.0			
2022-05-23	Cloudy	1st hr	08:30	42.0	41.0	08:30	41.0
		2nd hr	09:30	43.0			
		3rd hr	10:30	38.0			
2022-05-28	Fine	1st hr	09:20	48.0	47.3	09:20	47.0
		2nd hr	10:20	48.0			
		3rd hr	11:20	46.0			
Average :				41.7	Average :		41.6
Action Level :				278	Action Level :		144
Limit Level :				500	Limit Level :		260

**Appendix 3-7 - 1hour and 24 hours TSP Monitoring Result**

Reporting Month: 2022/05

**AMS1N – 1 – hour TSP monitoring Chart**

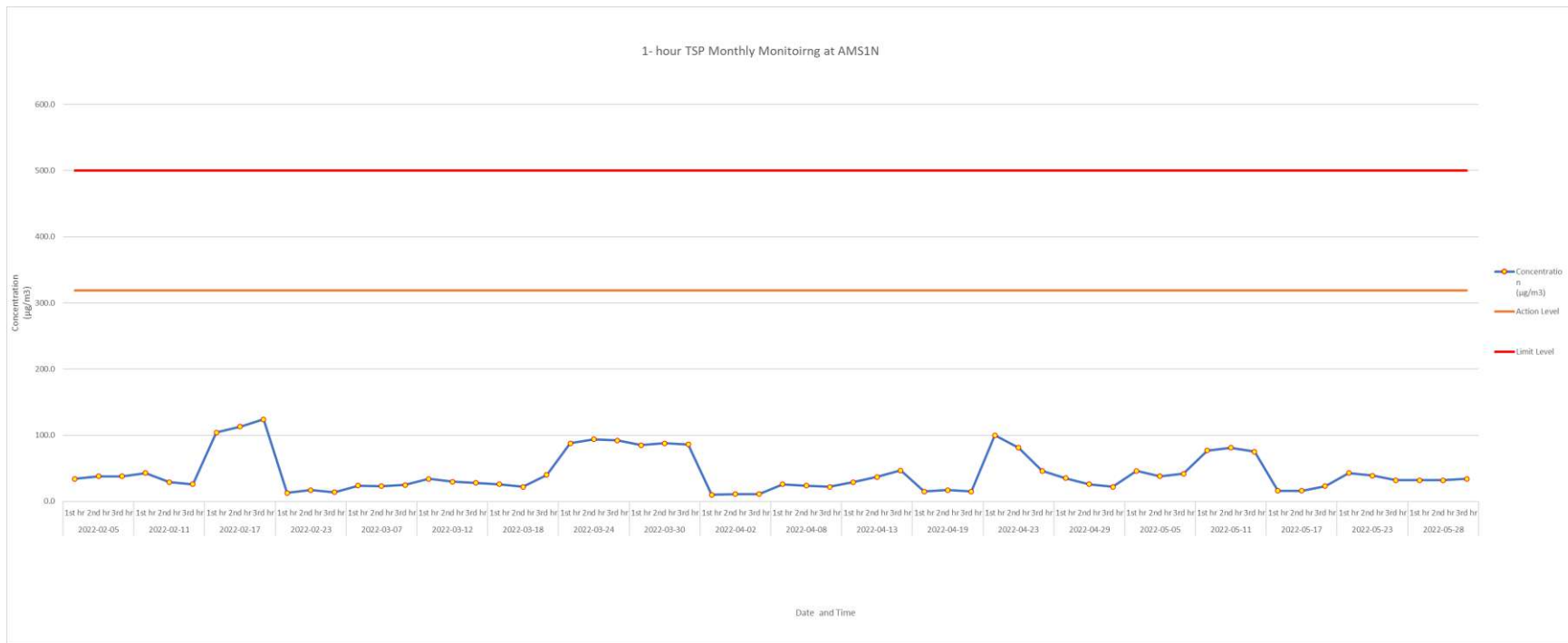

AMS1N – 24-hour TSP Monitoring

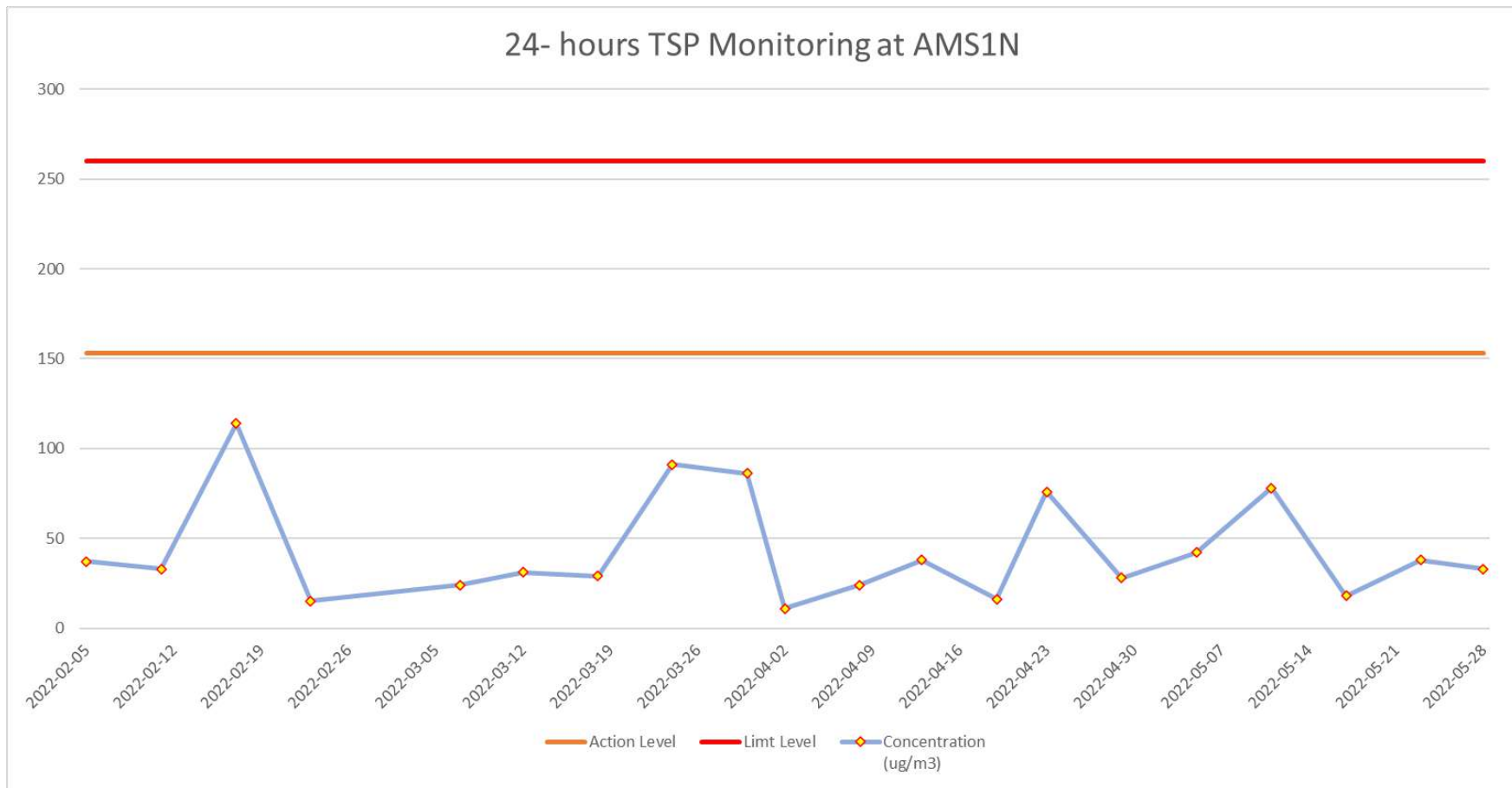



AMS2N1 – 1 – hour TSP monitoring Chart

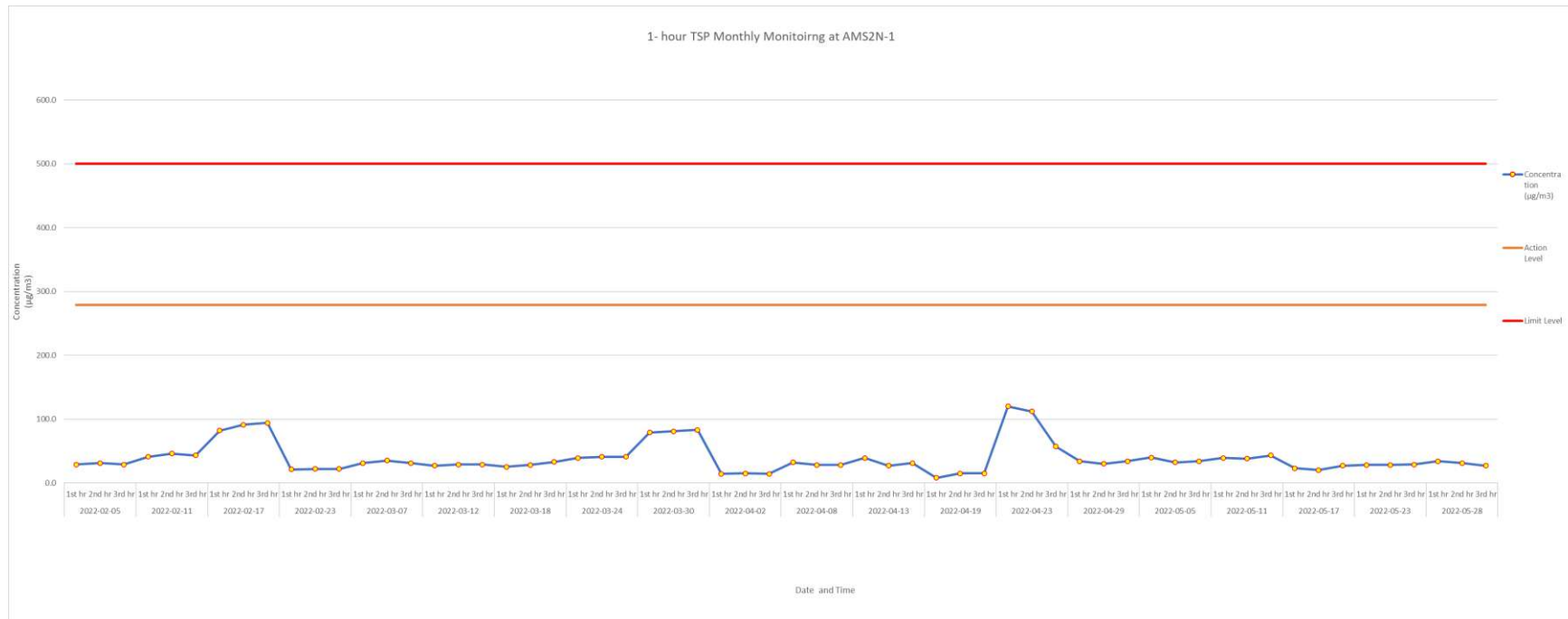

AMS2N1 – 24-hour TSP Monitoring

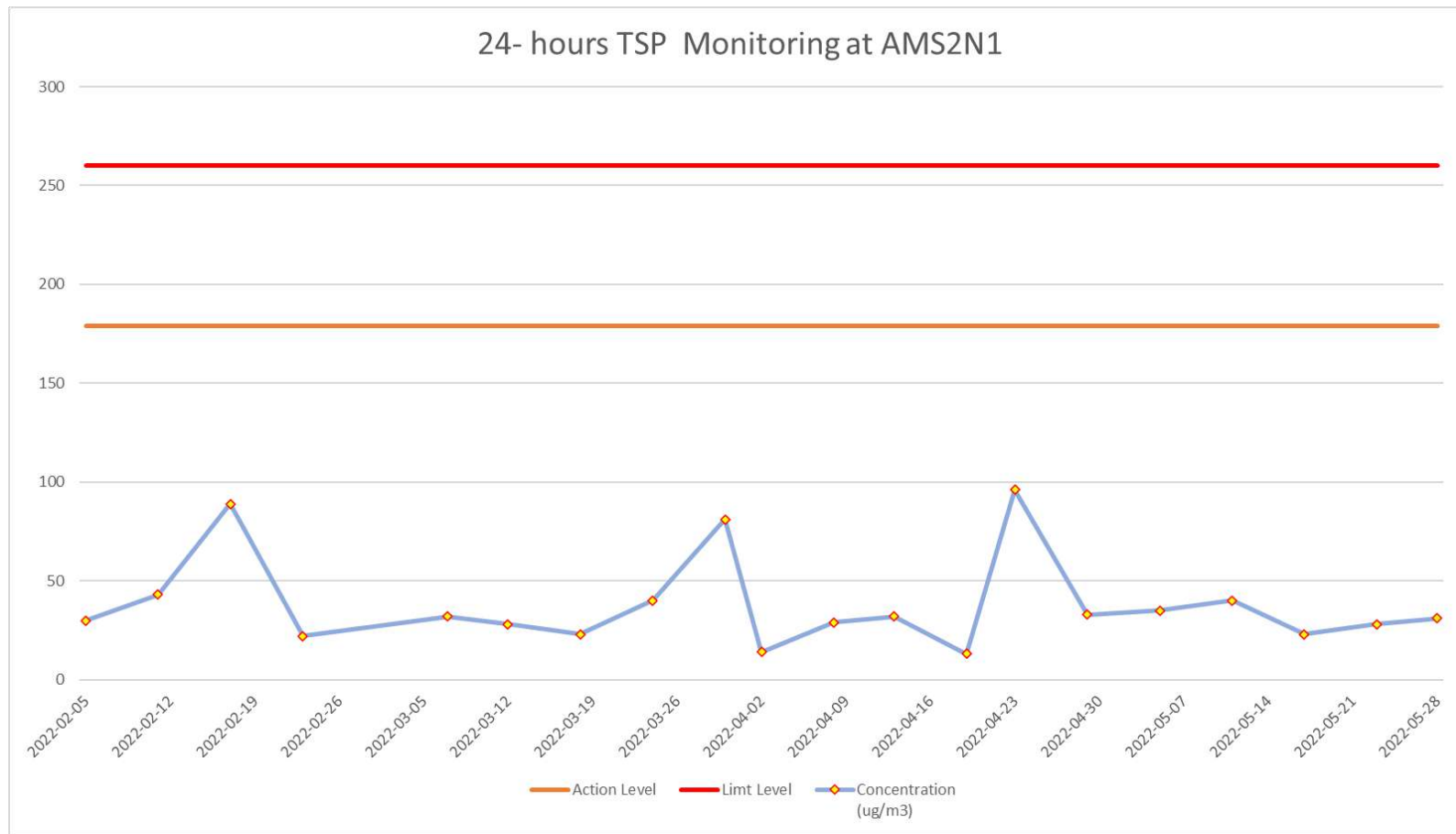

AMS3N – 1 – hour TSP monitoring Chart

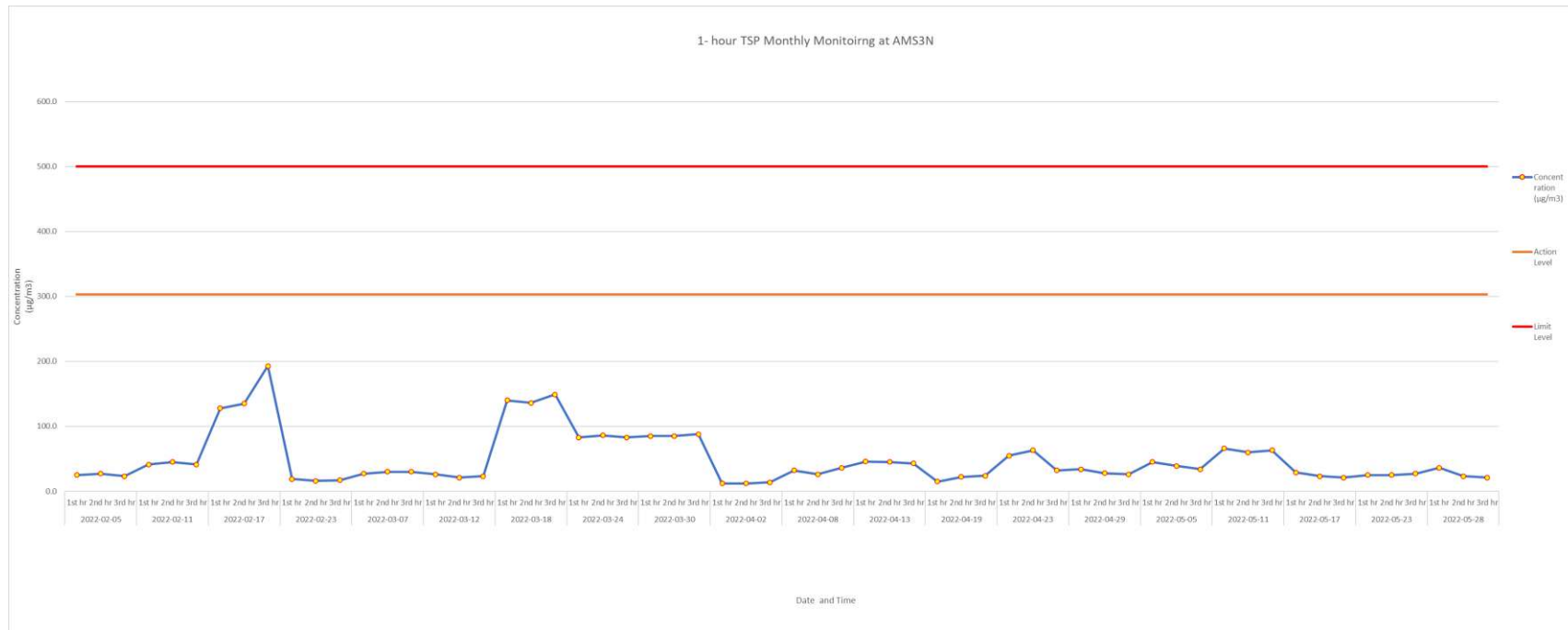

AMS3N – 24-hour TSP Monitoring

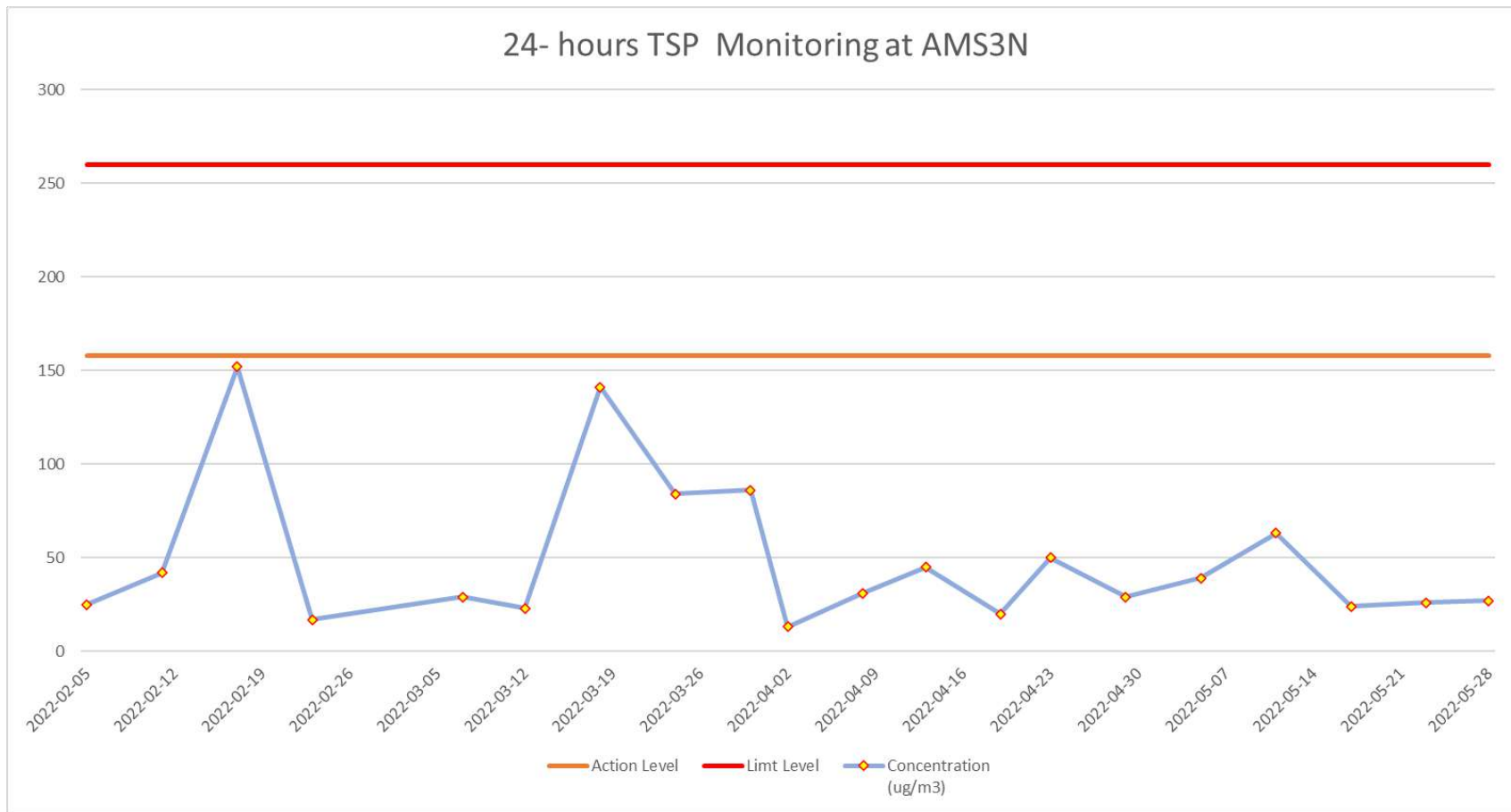

AMS4N – 1 – hour TSP Monitoring

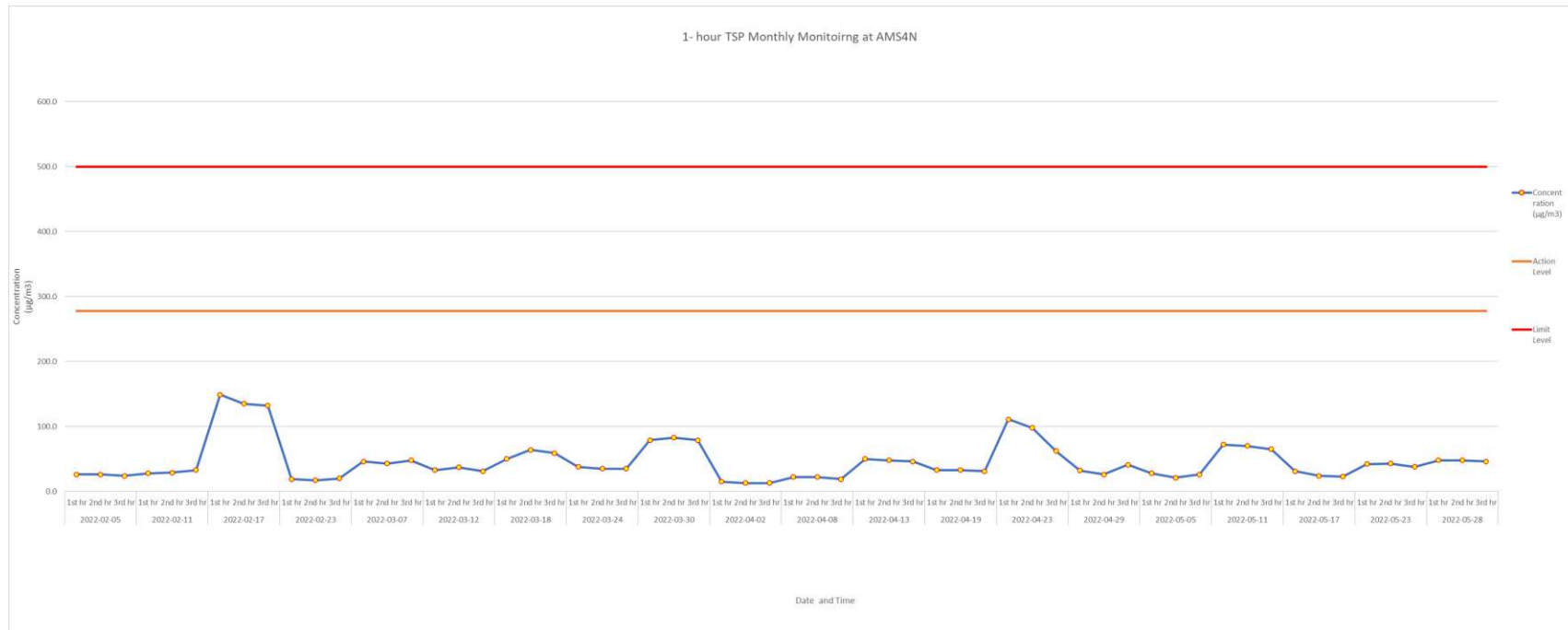

AMS4N – 24-hour TSP Monitoring

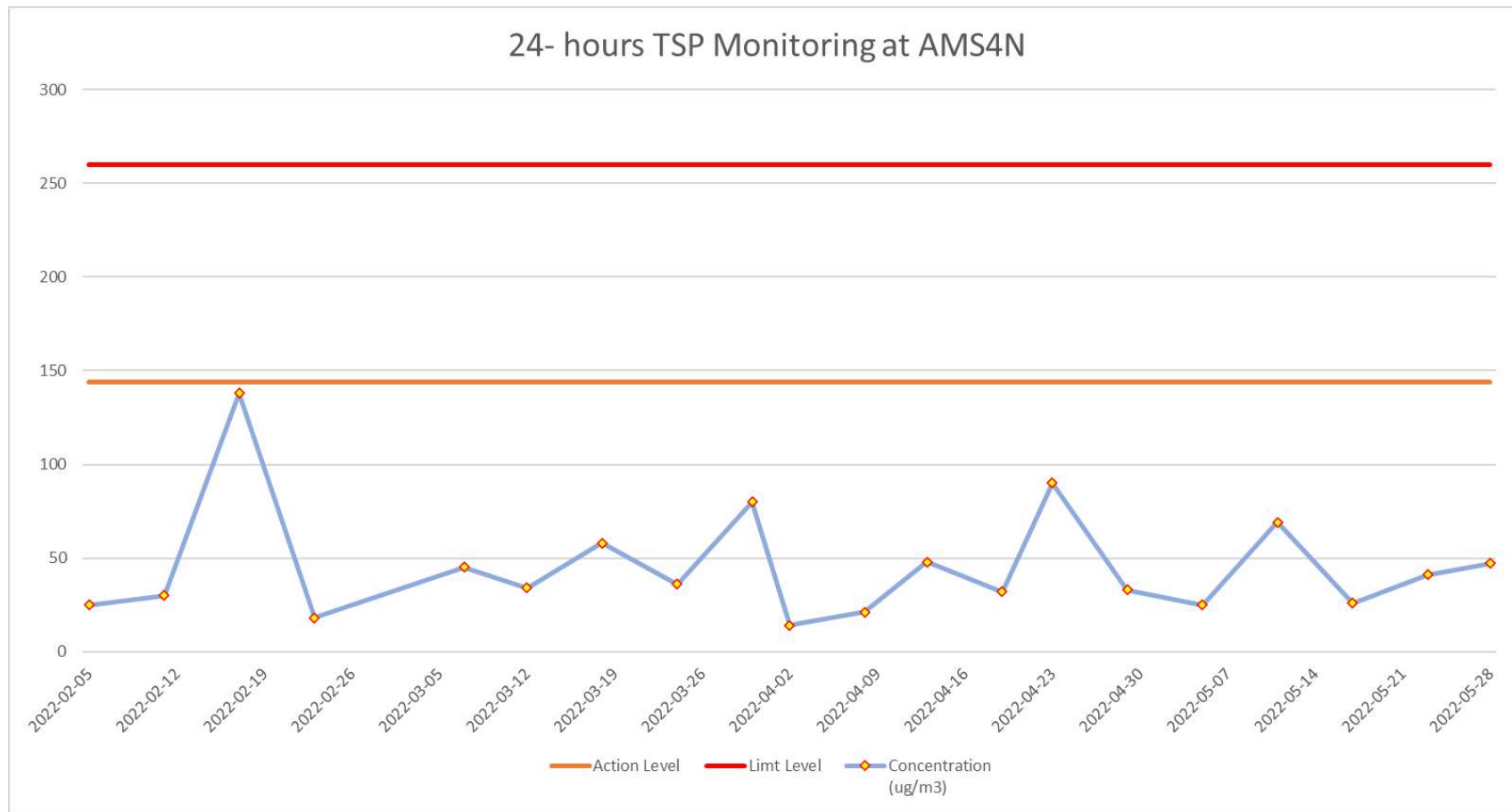

***Appendix 3-8***

---

*Event and Action Plan for Air Quality Monitoring*

**Appendix 3-8 Event and Action Plan for Air Quality Impact Monitoring**

EVENT	ACTION			
	ET	IEC	ER	CONTRACTOR
Action Level				
1.Exceedance for one sample	<ol style="list-style-type: none"> <li>1. Inform IEC, ER and Contractor;</li> <li>2. Identify source, investigate the causes of exceedance and propose remedial measures;</li> <li>3. Repeat measurement to confirm finding;</li> <li>4. 4. Increase monitoring frequency to daily.</li> </ol>	<ol style="list-style-type: none"> <li>1. Check monitoring data submitted by ET;</li> <li>2. Check Contractor's working method.</li> </ol>	<ol style="list-style-type: none"> <li>1. Notify Contractor</li> </ol>	<ol style="list-style-type: none"> <li>1. Rectify any unacceptable practice;</li> <li>2. 2. Amend working methods if appropriate.</li> </ol>
2.Exceedance for two or more consecutive samples	<ol style="list-style-type: none"> <li>1. Inform IEC, ER and Contractor;</li> <li>2. Identify source;</li> <li>3. Advise the ER on the effectiveness of the proposed remedial measures;</li> <li>4. Repeat measurements to confirm findings;</li> <li>5. Increase monitoring frequency to daily;</li> <li>6. Discuss with IEC, ER and Contractor on remedial actions required;</li> <li>7. If exceedance continues, arrange meeting with IEC and ER;</li> <li>8. If exceedance stops, cease additional monitoring.</li> </ol>	<ol style="list-style-type: none"> <li>1. Check monitoring data submitted by ET;</li> <li>2. Check Contractor's working method;</li> <li>3. Discuss with ET and Contractor on possible remedial measures</li> <li>4. Advise the ET/ER on the effectiveness of the proposed remedial measures;</li> <li>5. Supervise Implementation of remedial measures.</li> </ol>	<ol style="list-style-type: none"> <li>1. Confirm receipt of notification of failure in writing;</li> <li>2. Notify Contractor;</li> <li>3. Ensure remedial measures properly implemented.</li> </ol>	<ol style="list-style-type: none"> <li>1. Submit proposals for remedial to</li> <li>2. ER and IEC within 3 working days of notification;</li> <li>3. Implement the agreed proposals;</li> <li>4. Amend proposal if appropriate.</li> </ol>



Monthly Environmental Monitoring & Audit Report for Port Shelter Phase 3, Po Toi O Sewerage Treatment Plant

EVENT	ACTION			
	ET	IEC	ER	CONTRACTOR
Limit Level				
1.Exceedance for one sample	<ol style="list-style-type: none"> <li>1. Inform IEC, ER, Contractor and EPD;</li> <li>2. Identify source, investigate the causes of exceedance and propose remedial measures;</li> <li>3. Repeat measurement to confirm finding;</li> <li>4. Increase monitoring frequency to daily;</li> <li>5. Assess effectiveness of Contractor remedial actions and keep IEC, EPD and ER informed of the results.</li> </ol>	<ol style="list-style-type: none"> <li>1. Check monitoring data submitted by ET;</li> <li>2. Check Contractor's working method;</li> <li>3. Discuss with ET and Contractor on possible remedial measures;</li> <li>4. Advise the ER on the effectiveness of the proposed remedial measures;</li> <li>5. Supervise implementation of remedial measures.</li> </ol>	<ol style="list-style-type: none"> <li>1. Confirm receipt of notification of failure in writing;</li> <li>2. Notify Contractor;</li> <li>3. Ensure remedial measures properly implemented.</li> </ol>	<ol style="list-style-type: none"> <li>1. Take immediate action to avoid further exceedance;</li> <li>2. Discuss with ET and IEC on remedial actions</li> <li>3. Submit proposals for remedial actions to IEC within 3 working days of notification;</li> <li>4. Implement the agreed proposals;</li> <li>5. Amend proposal if appropriate.</li> </ol>
2.Exceedance for two or more consecutive samples	<ol style="list-style-type: none"> <li>1. Notify IEC, ER, Contractor and EPD;</li> <li>2. Identify source;</li> <li>3. Repeat measurement to confirm findings;</li> <li>4. Increase monitoring frequency to daily;</li> <li>5. Carry out analysis of Contractor's working procedures to determine possible mitigation to be implemented;</li> <li>6. Arrange meeting with IEC and ER and Contractor to discuss the remedial actions to be taken;</li> <li>7. Assess effectiveness of Contractor's remedial actions and keep IEC, EPD and ER informed of the results;</li> <li>8. If exceedance stops, cease additional monitoring.</li> </ol>	<ol style="list-style-type: none"> <li>1. Check monitoring data submitted by ET;</li> <li>2. Check Contractor's working method;</li> <li>3. Discuss amongst ER, ET, and Contractor on the potential remedial actions;</li> <li>4. Review Contractor's remedial actions whenever necessary to assure their effectiveness and advise the ER accordingly;</li> <li>5. Supervise the implementation of remedial measures.</li> </ol>	<ol style="list-style-type: none"> <li>1. Confirm receipt of notification of failure in writing;</li> <li>2. Notify Contractor;</li> <li>3. In consultation with the IEC, agree with the Contractor on the remedial measures to be implemented;</li> <li>4. Ensure remedial measures properly implemented;</li> <li>5. If exceedance continues, consider what portion of the work is responsible and instruct</li> <li>6. the Contractor to terminate that portion of work until the exceedance ceases.</li> </ol>	<ol style="list-style-type: none"> <li>1. Take immediate action to avoid</li> <li>2. further exceedance;</li> <li>3. Discuss with ET and IEC on remedial actions</li> <li>4. Submit proposals for remedial actions to ER and IEC within 3 working days of notification;</li> <li>5. Implement the agreed proposals;</li> <li>6. Resubmit proposals if problem still not under control;</li> <li>7. Stop the relevant portion of works as determined by the ER until the exceedance ceases.</li> </ol>

***Appendix 4-1***

---

*Noise Monitoring Equipment Calibration Certificates*



# Calibration Certificate

Certificate No. **110280**

Page 1 of 2 Pages

**Customer :** ETS-Testconsult Limited

**Address :** 8/F., Block B, Veristrong Industrial Centre, 34-36 Au Pui Wan St., Fotan, Hong Kong.

**Order No. :** Q14041

**Date of receipt :** 19-Oct-21

## Item Tested

**Description :** Sound Level Calibrator

**Manufacturer :** Rion

**I.D. :** ET/EN/002/01

**Model :** NC-73

**Serial No. :** 10196943

## Test Conditions

**Date of Test :** 3-Nov-21

**Supply Voltage :** --

**Ambient Temperature :** (23 ± 3)°C

**Relative Humidity :** (50 ± 25) %

## Test Specifications

Calibration check.

Ref. Document/Procedure : F21, Z02.

## Test Results

All results were within the manufacturer's specification.

The results are shown in the attached page(s).

Main Test equipment used:

<u>Equipment No.</u>	<u>Description</u>	<u>Cert. No.</u>	<u>Traceable to</u>
S014	Spectrum Analyzer	106615	NIM-PRC & SCL-HKSAR
S240	Sound Level Calibrator	106446	NIM-PRC & SCL-HKSAR
S041	Universal Counter	101743	SCL-HKSAR
S206	Sound Level Meter	106447	SCL-HKSAR

The values given in this Calibration Certificate only relate to the values measured at the time of the test and any uncertainties quoted will not include allowance for the equipment long term drift, variations with environmental changes, vibration and shock during transportation, overloading, mis-handling, or the capability of any other laboratory to repeat the measurement. Hong Kong Calibration Ltd. shall not be liable for any loss or damage resulting from the use of the equipment.

The test equipment used for calibration are traceable to International System of Units (SI), or by reference to a natural constant.  
The test results apply to the above Unit-Under-Test only

**Calibrated by :**   
Elva Chong

**Approved by :**   
Kin Wong

**Date:** 3-Nov-21

This Certificate is issued by:  
Hong Kong Calibration Ltd.  
Unit 8B, 24/F., Well Fung Industrial Centre, No. 58-76, Ta Chuen Ping Street, Kwai Chung, NT, Hong Kong.  
Tel: 2425 8801 Fax: 2425 8646

The copyright of this certificate is owned by Hong Kong Calibration Ltd., It may not be reproduced except in full.



# Calibration Certificate

Certificate No. 110280

Page 2 of 2 Pages

Results :

**1. Level Accuracy (at 1 kHz)**

UUT Nominal Value	Measured Value	Mfr's Spec.
94.0 dB	93.9 dB	$\pm 1$ dB

Uncertainty :  $\pm 0.2$  dB

**2. Frequency Accuracy**

UUT Nominal Value	Measured Value	Mfr's Spec.
1 kHz	0.982 kHz	$\pm 2$ %

Uncertainty :  $\pm 0.1$  %

**3. Level Stability : 0.0 dB**

Uncertainty :  $\pm 0.01$  dB

**4. Total Harmonic Distortion :  $< 0.3$  %**

Mfr's Spec. :  $< 3$  %

Uncertainty :  $\pm 2.3$  % of reading

Remarks: 1. UUT : Unit-Under-Test  
2. The uncertainty claimed is for a confidence probability of not less than 95%.  
3. Atmospheric Pressure : 1 009 hPa

----- END -----



# Calibration Certificate

Certificate No. **110279**

Page 1 of 2 Pages

**Customer :** ETS-Testconsult Limited

**Address :** 8/F., Block B, Veristrong Industrial Centre, 34-36 Au Pui Wan St., Fotan, Hong Kong.

**Order No. :** Q14041

**Date of receipt :** 19-Oct-21

## Item Tested

**Description :** Thermo-Anemometer

**Manufacturer :** AZ Instrument

**Model :** AZ 8908

**I.D. :** ET/EN/001/05

**Serial No. :** 1064869

## Test Conditions

**Date of Test :** 28-Oct-21

**Ambient Temperature :** (23 ± 3)°C

**Supply Voltage :** --

**Relative Humidity :** (50 ± 25) %

## Test Specifications

Calibration check.

Calibration procedure : T03, Z04.

## Test Results

A correction factor of x 1.1 is required to bring the meter reading to within the manufacturer's specification.  
The results are shown in the attached page(s).

Main Test equipment used:

<u>Equipment No.</u>	<u>Description</u>	<u>Cert. No.</u>	<u>Traceable to</u>
S155	Std. Anemometer	008674	NIM-PRC
S223C	Std. Thermometer	104830	NIM-PRC

The values given in this Calibration Certificate only relate to the values measured at the time of the test and any uncertainties quoted will not include allowance for the equipment long term drift, variations with environmental changes, vibration and shock during transportation, overloading, mis-handling, or the capability of any other laboratory to repeat the measurement. Hong Kong Calibration Ltd. shall not be liable for any loss or damage resulting from the use of the equipment.

The test equipment used for calibration are traceable to International System of Units (SI), or by reference to a natural constant.  
The test results apply to the above Unit-Under-Test only

Calibrated by : 

James Yau

Approved by : 

Steve Kwan

Date: 28-Oct-21

This Certificate is issued by:

Hong Kong Calibration Ltd.

Unit 8B, 24/F., Well Fung Industrial Centre, No. 58-76, Ta Chuen Ping Street, Kwai Chung, NT, Hong Kong.

Tel: 2425 8801 Fax: 2425 8646



# Calibration Certificate

Certificate No. 110279

Page 2 of 2 Pages

Results :

## 1. Velocity

Applied Value (m/s)	UUT Reading (m/s)	Corrected rdg. (=UUT rdg. × 1.1)	Mfr's Spec.
0.00	0.0	0.0	± (3% of reading + 0.2 m/s)
2.50	2.4	2.6	
5.00	4.7	5.2	
10.00	*9.2	10.1	
15.00	*13.8	15.2	
19.00	*17.6	19.4	

## 2. Temperature

Applied Value (°C)	UUT Reading (°C)	Mfr's Spec.
23.04	22.7	± 1 °C

Remark : 1. UUT: Unit-Under-Test

2. Uncertainty : ± (0.9% + 0.16 m/s) for Velocity, ± 0.1 °C for Temperature, for a confidence probability of not less than 95%.

3. Atmospheric Pressure : 1 006 hPa

4. \*Out of Specification

----- END -----

***Appendix 4-2***

---

*Noise Impact Monitoring Results*

Project No. 1825

Monthly Environmental Monitoring & Audit Report for Port Shelter Phase 3, Po Toi O Sewerage Treatment Plant

Appendix 4-2 : Noise Monitoring Data

Month 2022/05

Monitoring Location :		NMS1N		
Date	Leq30min dB(A)*	L10 dB(A)	L90 dB(A)	Limit Level dB(A)
2022-05-05	56.3	59.1	39.7	75
2022-05-11	62.8	67.7	58.5	75
2022-05-17	67.7	71.4	56.3	75
2022-05-23	64.2	68.2	53.0	75
Average :	64.3			
Action Level :	When one valid documented complaint is received			
Limit Level :	75.0 dB(A)			
* Remark: For Free-field measurement, a correction of +3dB(A) should be made to the measured results.				

Monitoring Location :		NMS2N1		
Start Date & Time	Leq30min dB(A)*	L10 dB(A)	L90 dB(A)	Limit Level dB(A)
2022-05-05	53.0	54.5	50.5	75
2022-05-11	59.7	62.3	56.8	75
2022-05-17	57.8	59.8	54.9	75
2022-05-23	60.1	62.4	53.0	75
Average :	58.4			
Action Level :	When one valid documented complaint is received			
Limit Level :	75.0 dB(A)			
* Remark: For Free-field measurement, a correction of +3dB(A) should be made to the measured results.				

Monitoring Location :		NMS3N		
Start Date & Time	Leq30min dB(A)*	L10 dB(A)	L90 dB(A)	Limit Level dB(A)
2022-05-05	57.2	60.0	53.2	75
2022-05-11	60.6	62.8	57.3	75
2022-05-17	65.3	68.3	59.0	75
2022-05-23	60.7	63.1	57.5	75
Average :	61.9			
Action Level :	When one valid documented complaint is received			
Limit Level :	75.0 dB(A)			
* Remark: For Free-field measurement, a correction of +3dB(A) should be made to the measured results.				

Monitoring Location :		NMS4N		
Start Date & Time	Leq30min dB(A)*	L10 dB(A)	L90 dB(A)	Limit Level dB(A)
2022-05-05	53.5	55.9	47.9	75
2022-05-11	64.4	67.7	60.5	75
2022-05-17	49.3	51.3	44.1	75
2022-05-23	53.4	56.2	48.5	75
Average :	59.2			
Action Level :	When one valid documented complaint is received			
Limit Level :	75.0 dB(A)			
* Remark: For Free-field measurement, a correction of +3dB(A) should be made to the measured results.				



**Appendix 4-2 - Noise Monitoring Data Chart**

Monitoring Station: NMS1N

Leq30 minutes Impact Monitoring

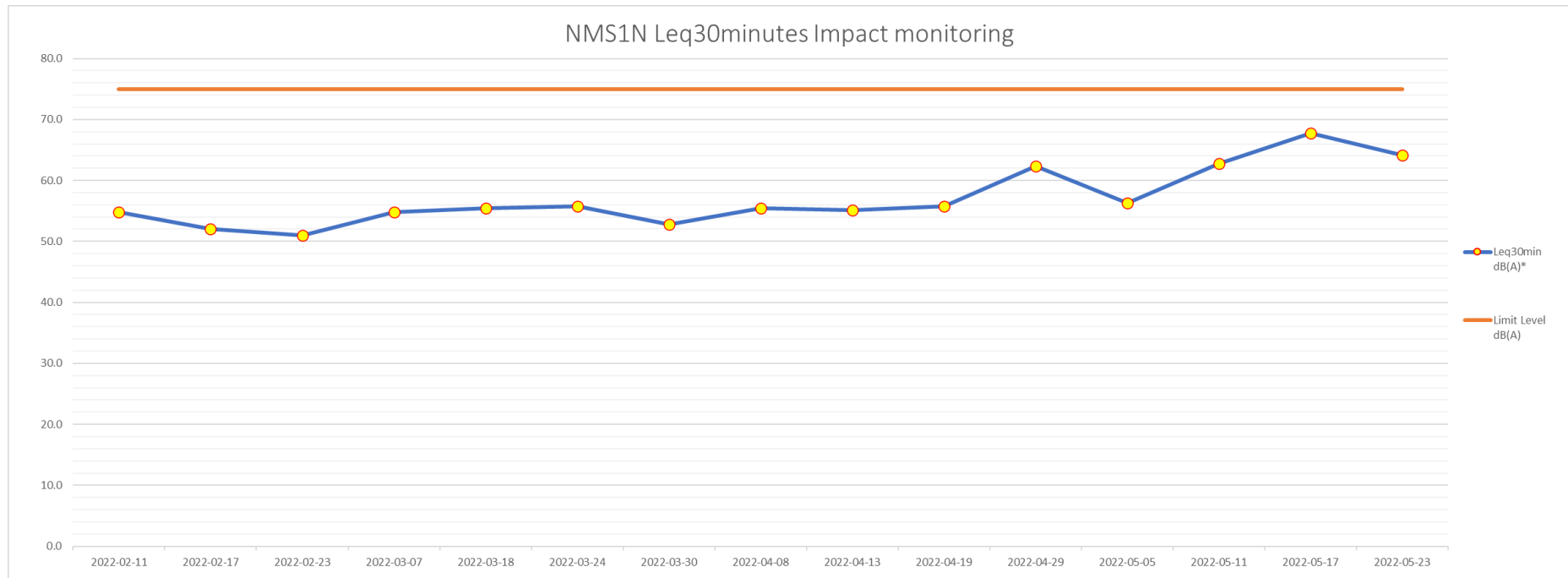

Monitoring Station: NMS2N1

Leq30 minutes Impact Monitoring

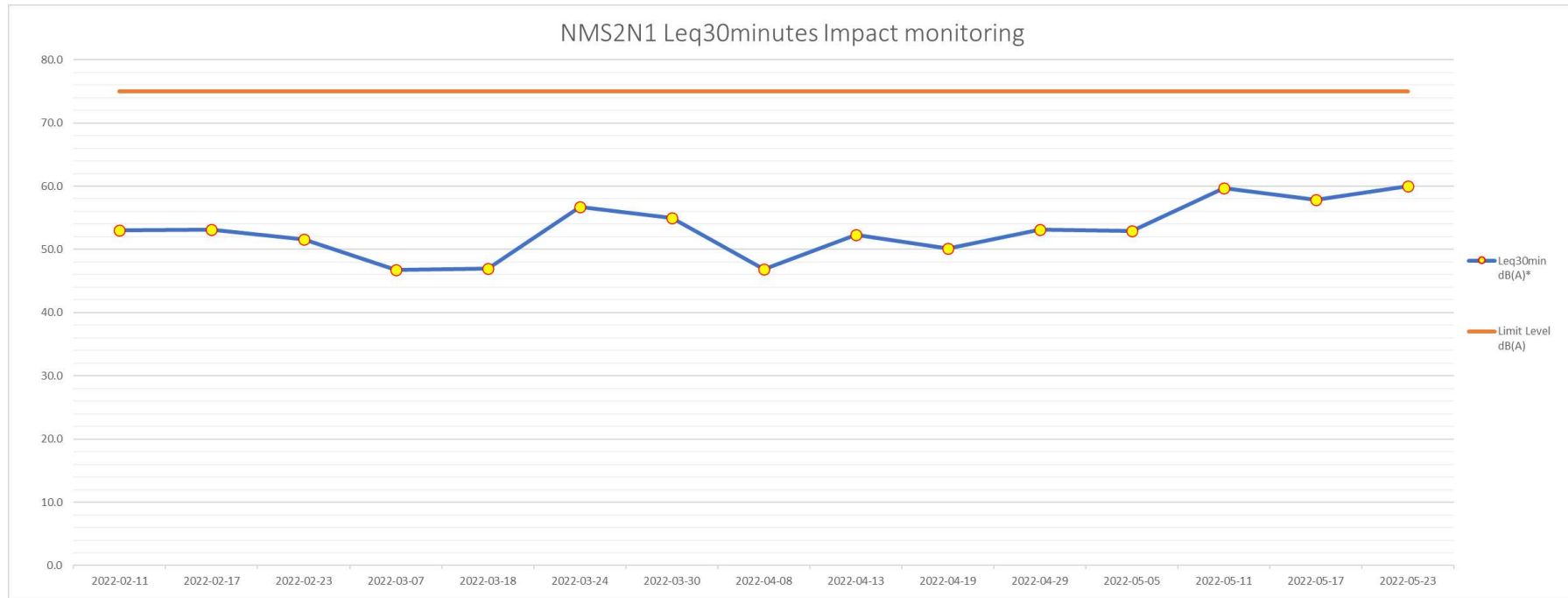

Monitoring Station: NMS3N

Leq30 minutes Impact Monitoring

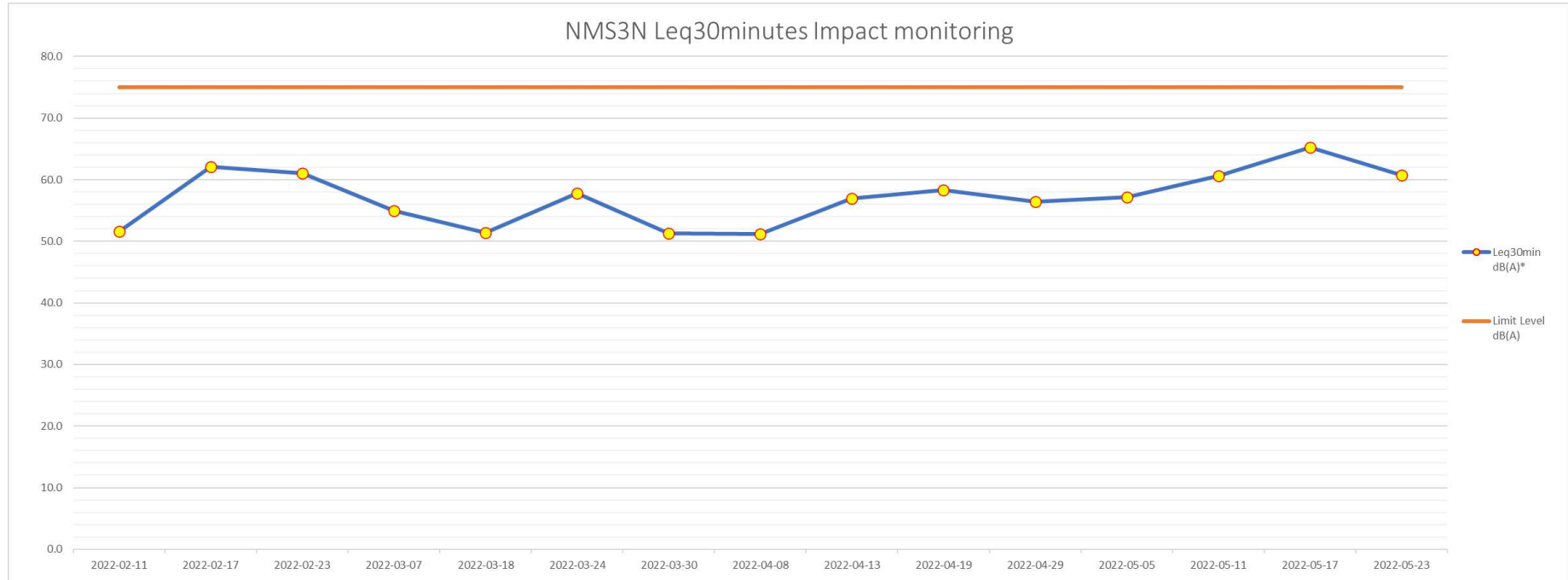

Monitoring Station: NMS4N

Leq30 minutes Impact Monitoring

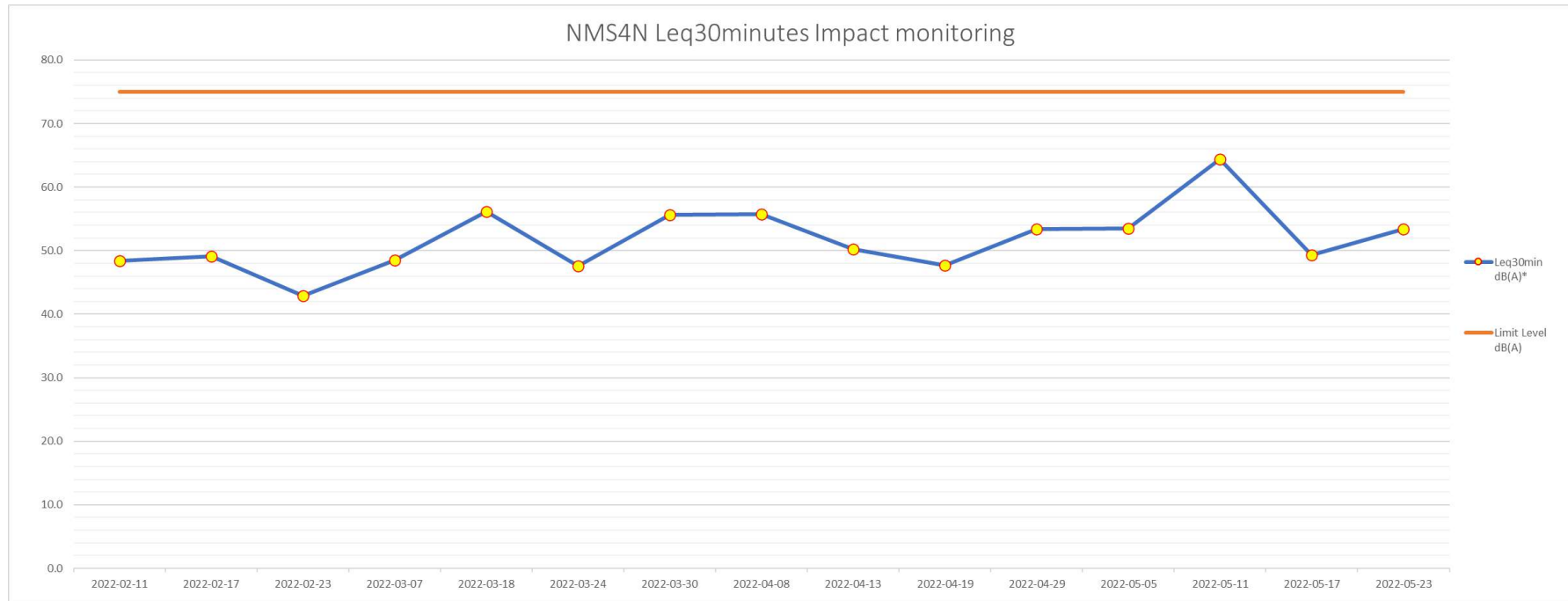

***Appendix 4-3***

---

*Event and Action Plan for Noise Impact Monitoring*

**Appendix 4-3 Event and Action Plan for Noise Impact Monitoring**

EVENT	ACTION			
	ET	IEC	ER	Contractor
Action Level	1. Notify IEC, ER and Contractor of exceedance; 2. Identify source 3. Investigate the causes of exceedance and propose remedial measures; 4. Report the results of investigation to the IEC, ER and Contractor; 5. Discuss with the IEC, ER and Contractor and formulate remedial measures; 6. Increase monitoring frequency to check mitigation effectiveness.	1. Review the analysed results submitted by the ET; 2. Review the proposed remedial measures by the Contractor and advise the ER accordingly; 3. Supervise the implementation of remedial measures.	1. Confirm receipt of notification of failure in writing; 2. Notify Contractor; 3. Require Contractor to propose remedial measures for the analysed noise problem; 4. Ensure remedial measures are properly implemented	1. Submit noise mitigation proposals to ER with copy to ET and IEC; Implement noise mitigation proposals.

EVENT	ACTION			
	ET	IEC	ER	CONTRACTOR
Limit Level				
	<ol style="list-style-type: none"> <li>1. Inform IEC, ER, EPD and Contractor;</li> <li>2. Identify source;</li> <li>3. Repeat measurements to confirm findings;</li> <li>4. Increase monitoring frequency;</li> <li>5. Carry out analysis of Contractor's working procedures to determine possible mitigation to be implemented;</li> <li>6. Inform IEC, ER and EPD the causes and actions taken for the exceedances;</li> <li>7. Assess effectiveness of Contractor's remedial actions and keep IEC, EPD and ER informed of the results;</li> <li>8. If exceedance stops, cease additional monitoring.</li> </ol>	<ol style="list-style-type: none"> <li>1. Discuss amongst ER, ET, and Contractor on the potential remedial actions;</li> <li>2. Review Contractor's remedial actions whenever necessary to assure their effectiveness and advise the ER accordingly;</li> <li>3. Supervise the implementation of remedial measures.</li> </ol>	<ol style="list-style-type: none"> <li>1. Confirm receipt of notification of failure in writing;</li> <li>2. Notify Contractor;</li> <li>3. Require Contractor to propose remedial measures for the analysed noise problem;</li> <li>4. Ensure remedial measures are properly implemented;</li> <li>5. If exceedance continues, investigate what portion of the work is responsible and instruct the Contractor to terminate that portion of work until the exceedance ceases.</li> </ol>	<ol style="list-style-type: none"> <li>1. Take immediate action to avoid further exceedance;</li> <li>2. Submit proposals for remedial actions to ER with copy to ET and IEC within 3 working days of notification;</li> <li>3. Implement the agreed proposals;</li> <li>4. Resubmit proposals if problem still not under control;</li> <li>5. Terminate the relevant portion of works as determined by the ER until the exceedance ceases.</li> </ol>

***Appendix 6-1***

---

*Monthly Waste Flow Table*



**Appendix 6-1 Monthly Summary Waste Flow Table****Monthly Summary Waste Flow Table for 2022 (year)**

Name of Department: DSD

Contract No. DC 2019/09 Port Shelter Phase 3, Po Toi O Sewage Treatment Plant

Month	Actual Quantities of Inert C&D Materials Generated Monthly						Actual Quantities of C&D Wastes Generated Monthly				
	Total Quantity Generated	Hard Rock and Large Broken Concrete	Reused in the Contract	Reused in other Projects	Disposed as Public Fill	Imported Fill	Metals	Paper/ cardboard packaging	Plastics (see notes 3)	Chemical Waste	Others, e.g. general refuse
	(in '000m <sup>3</sup> )	(in '000m <sup>3</sup> )	(in '000m <sup>3</sup> )	(in '000m <sup>3</sup> )	(in '000m <sup>3</sup> )	(in '000m <sup>3</sup> )	(in '000kg)	(in '000kg)	(in '000kg)	(in '000kg)	(in '000m <sup>3</sup> )
Jan	0.142	0.000	0.000	0.000	0.142	0.000	0.000	0.000	0.000	0.000	0.000
Feb	0.100	0.000	0.000	0.000	0.100	0.000	0.000	0.000	0.000	0.000	0.000
Mar	0.040	0.000	0.000	0.000	0.040	0.000	0.000	0.000	0.000	0.000	0.000
Apr	0.010	0.000	0.000	0.000	0.010	0.000	0.000	0.000	0.000	0.000	0.000
May	0.066	0.000	0.000	0.000	0.064	0.000	0.000	0.000	0.000	0.000	0.002
June	0.000	0.000	0.000	0.000	0.000	0.000	0.000	0.000	0.000	0.000	0.000
<b>Sub-Total</b>	<b>0.358</b>	<b>0.000</b>	<b>0.000</b>	<b>0.000</b>	<b>0.356</b>	<b>0.000</b>	<b>0.000</b>	<b>0.000</b>	<b>0.000</b>	<b>0.000</b>	<b>0.002</b>
July	0.000	0.000	0.000	0.000	0.000	0.000	0.000	0.000	0.000	0.000	0.000
Aug	0.000	0.000	0.000	0.000	0.000	0.000	0.000	0.000	0.000	0.000	0.000
Sep	0.000	0.000	0.000	0.000	0.000	0.000	0.000	0.000	0.000	0.000	0.000
Oct	0.000	0.000	0.000	0.000	0.000	0.000	0.000	0.000	0.000	0.000	0.000
Nov	0.000	0.000	0.000	0.000	0.000	0.000	0.000	0.000	0.000	0.000	0.000
Dec	0.000	0.000	0.000	0.000	0.000	0.000	0.000	0.000	0.000	0.000	0.000
<b>Total</b>	<b>0.358</b>	<b>0.000</b>	<b>0.000</b>	<b>0.000</b>	<b>0.356</b>	<b>0.000</b>	<b>0.000</b>	<b>0.000</b>	<b>0.000</b>	<b>0.000</b>	<b>0.002</b>

- Notes:
- (1) The performance targets are given in the Environmental Management Plan.
  - (2) The waste flow table shall also include C&D materials to be imported for use at the Site.
  - (3) Plastics refer to plastic bottles/containers, plastic sheets/foam from packaging material.

***Appendix 6-2***

---

*Implementation Schedule of Recommended Mitigation Measures*

**Annex A - Implementation Schedule of Recommended Mitigation Measures**

<b>EIA Ref.</b>	<b>EM&amp;A Ref.</b>	<b>Recommended Mitigation Measures *</b>	<b>Objectives of the Recommended Measure &amp; Main Concerns to address</b>	<b>Implementation Agent</b>	<b>Location of the measure</b>	<b>Duration of the measure</b>	<b>Implementation stages</b>	<b>Relveant Legislation &amp; Guidelines</b>
<b>Air Quality Impact</b>								
<b>Project Specific Measures</b>								
3.8	A1	Deodourizer should have at least 99.5% hydrogen sulfide removal efficiency.	To minimize odour nuisance to sensitive receivers	DSD	Sewage Treatment Plant	Throughout operational phase	Operational phase	EIAO-TM
3.8	A2	Odourous materials (sludge, screenings and grits, worn filter) should be stored and removed in sealed tankers and containers.	To minimize odour nuisance to sensitive receivers	DSD	Sewage Treatment Plant	Throughout operational phase	Operational phase	EIAO-TM
3.8	A3	Sludge should be transferred to sludge tanker by coupling method.	To minimize odour nuisance to sensitive receivers	DSD	Sewage Treatment Plant	Throughout operational phase	Operational phase	EIAO-TM
3.8	A4	During release of pressure from the tanker, the odourous gas should be discharged into the sludge storage room for extraction to deodourization unit.	To minimize odour nuisance to sensitive receivers	DSD	Sewage Treatment Plant	Throughout operational phase	Operational phase	EIAO-TM
3.8	A5	Regular inspection should be conducted to check for leakage of odourous gas	To minimize odour nuisance to sensitive receivers	DSD	Sewage Treatment Plant	Throughout operational phase	Operational phase	EIAO-TM
3.8	A6	Maintain the removal efficiency of screenings and grits by flushing the screens and grit sump regularly to prevent build up of solids	To maintain the removal efficiency of screenings and grits	DSD	Sewage Treatment Plant	Throughout operational phase	Operational phase	EIAO-TM
3.8	A7	Maintain the efficiency of MBR membrane by removing organic and inorganic debris regularly	To maintain the efficiency of MBR membrane	DSD	Sewage Treatment Plant	Throughout operational phase	Operational phase	EIAO-TM
3.8	A8	Replace worn filter to maintain the odour removal efficiency at 99.5%	To minimize odour nuisance to sensitive receivers	DSD	Sewage Treatment Plant	Throughout operational phase	Operational phase	EIAO-TM
3.8	A9	Clean all the tanks with water regularly	To minimize odour nuisance to sensitive receivers	DSD	Sewage Treatment Plant	Throughout operational phase	Operational phase	EIAO-TM
<b>Generic/Standard Measures</b>								
3.8	A10	Good housekeeping to minimize dust generation, e.g. by properly handling and storing dusty materials	To minimize dust generation	DSD's Contractor	Whole construction site	Throughout construction phase	Construction phase	EIAO-TM, APCO
3.8	A11	Adopt dust control measures, such as dust suppression using water spray on exposed soil (at least 4 times per day), in areas with dusty construction activities and during material handling	To minimize dust generation due to erosion	DSD's Contractor	Whole construction site	Throughout construction phase	Construction phase	EIAO-TM, APCO

**Annex A - Implementation Schedule of Recommended Mitigation Measures**

<b>EIA Ref.</b>	<b>EM&amp;A Ref.</b>	<b>Recommended Mitigation Measures *</b>	<b>Objectives of the Recommended Measure &amp; Main Concerns to address</b>	<b>Implementation Agent</b>	<b>Location of the measure</b>	<b>Duration of the measure</b>	<b>Implementation stages</b>	<b>Relevant Legislation &amp; Guidelines</b>
3.8	A12	Store cement bags in shelter with 3 sides and the top covered by impervious materials if the stack exceeds 20 bags	To prevent leakage of cement	DSD's Contractor	Whole construction site	Throughout construction phase	Construction phase	EIAO-TM, APCO
3.8	A13	Maintain a reasonable height when dropping excavated materials to limit dust generation	To minimize dust generation during movement of excavated materials	DSD's Contractor	Whole construction site	Throughout construction phase	Construction phase	EIAO-TM, APCO
3.8	A14	Limit vehicle speed within construction site and in Po Toi O to 10km/hr and confine vehicle movement in haul road	To minimize dust generation due to traffic movement	DSD's Contractor	Whole construction site	Throughout construction phase	Construction phase	EIAO-TM, APCO
3.8	A15	Minimize exposed earth after completion of work in a certain area by hydroseeding, vegetating, soil compacting or covering with bitumen	To minimize dust generation due to erosion	DSD's Contractor	Whole construction site	Throughout construction phase	Construction phase	EIAO-TM, APCO
3.8	A16	Provide wheel washing at construction site exit to clean the vehicle body and wheel	To prevent dust from being brought offsite	DSD's Contractor	Whole construction site	Throughout construction phase	Construction phase	EIAO-TM, APCO
3.8	A17	Cover materials on trucks before leaving the construction site to prevent debris from dropping during traffic movement or being blown away by wind	To prevent falling of debris during traffic movement and by wind	DSD's Contractor	Whole construction site	Throughout construction phase	Construction phase	EIAO-TM, APCO
3.8	A18	Regular maintenance of plant equipment to prevent black smoke emission	To minimize black smoke emission	DSD's Contractor	Whole construction site	Throughout construction phase	Construction phase	EIAO-TM, APCO
3.8	A19	Throttle down or switch off unused machines or machine in intermittent use	To minimize unnecessary emission	DSD's Contractor	Whole construction site	Throughout construction phase	Construction phase	EIAO-TM, APCO
3.8	A20	Minimize excavation area as far as possible	To minimize dust emission and potential release of odour from exposed ground	DSD's Contractor	Whole construction site	Throughout construction phase	Construction phase	EIAO-TM, APCO
3.8	A21	Store odourous excavated materials in covered containers and remove off-site as soon as possible within 24 hours	To minimize odour nuisance to sensitive receivers	DSD's Contractor	Whole construction site	Throughout construction phase	Construction phase	EIAO-TM, APCO
3.8	A22	Cover open stockpiles of construction materials (e.g. aggregates, sand and fill materials) with impermeable materials such as tarpaulin during rainstorms.	To prevent soil erosion under rainstorm	DSD's Contractor	Whole construction site	Throughout construction phase	Construction phase	EIAO-TM, APCO
3.8	A23	Hoarding of not less than 2.4 m high shall be erected from ground level to surround the construction site for sewage treatment plant along Po Toi O Chuen Road except for a construction site entrance or exit	To minimize dust emission	DSD's Contractor	Whole construction site	Throughout construction phase	Construction phase	EIAO-TM, APCO

Annex A - Implementation Schedule of Recommended Mitigation Measures

<b>EIA Ref.</b>	<b>EM&amp;A Ref.</b>	<b>Recommended Mitigation Measures *</b>	<b>Objectives of the Recommended Measure &amp; Main Concerns to address</b>	<b>Implementation Agent</b>	<b>Location of the measure</b>	<b>Duration of the measure</b>	<b>Implementation stages</b>	<b>Relveant Legislation &amp; Guidelines</b>
3.8	A24	Carry out air quality monitoring throughout the construction period	To monitor construction dust level	DSD's Contractor	At representative ASRs	Prior to and throughout construction phase	Construction phase	EIAO-TM
3.8	A25	Carry out regular site inspection to audit the implementation of mitigation measures	To check the implementation status and effectiveness of mitigation measures	DSD's Contractor	Whole construction site	Throughout construction phase	Construction phase	EIAO-TM, APCO

Annex A - Implementation Schedule of Recommended Mitigation Measures

EIA Ref.	EM&A Ref.	Recommended Mitigation Measures *	Objectives of the Recommended Measure & Main Concerns to address	Implementation Agent	Location of the measure	Duration of the measure	Implementation stages	Relveant Legislation & Guidelines
<b>Noise Impact</b>								
Project Specific Measures								
4.7	N1	Use hand-held plant equipment or manual equipment within village area	To minimize construction noise level	DSD's Contractor	Whole construction site	Throughout construction phase	Construction phase	NCO, EIAO-TM
4.7	N2	For HDD, enclose the stationary plant equipment on three sides with cover. Only the side facing the sea shall be opened for heat exhaustion.	To lower noise transmission	DSD's Contractor	HDD work site	Throughout construction phase	Construction phase	NCO, EIAO-TM
4.7	N3	Generator should be placed at a fixed location at least 5-6m away from the NSRs and screened by noise barrier whenever excavation work has to be carried out at their front doors	To lower noise transmission	DSD's Contractor	Whole construction site	Throughout construction phase	Construction phase	NCO, EIAO-TM
4.7	N4	Avoid carrying out noisy activities at the same time. The work front of village sewer installation near NSRs PTO_N1 and PTO_N3 shall not be conducted concurrently with installation of Po Toi O Chuen Road sewer and horizontal directional drilling respectively.	To minimize noise production	DSD's Contractor	Whole construction site	When the respective workfront next to the NSR is carried out	Construction phase	NCO, EIAO-TM
4.7	N5	Vibratory poker shall only be operated 4m away from NSR and with noise barrier properly erected. Surfacing work within 4m from NSR shall be carried out by manual method.	To minimize noise production	DSD's Contractor	Whole construction site	When the respective workfront next to the NSR is carried out	Construction phase	NCO, EIAO-TM
Generic/Standard Measures								
4.7	N6	Schedule noisy activities to minimise exposure of nearby NSRs to high levels of construction noise	To minimize construction noise level	DSD's Contractor	Whole construction site	Throughout construction phase	Construction phase	NCO, EIAO-TM
4.7	N7	Use Quality Powered Mechanical Equipment (QPME) which produces lower noise level	To minimize construction noise level	DSD's Contractor	Whole construction site	Throughout construction phase	Construction phase	NCO, EIAO-TM
4.7	N8	Erect 3m high mobile barriers with skid footing and a small cantilevered upper portion within a few metres of stationary plants and within about 5m of more mobile plant.	To lower noise transmission	DSD's Contractor	Whole construction site	Throughout construction phase	Construction phase	NCO, EIAO-TM

Annex A - Implementation Schedule of Recommended Mitigation Measures

<b>EIA Ref.</b>	<b>EM&amp;A Ref.</b>	<b>Recommended Mitigation Measures *</b>	<b>Objectives of the Recommended Measure &amp; Main Concerns to address</b>	<b>Implementation Agent</b>	<b>Location of the measure</b>	<b>Duration of the measure</b>	<b>Implementation stages</b>	<b>Relveant Legislation &amp; Guidelines</b>
4.7	N9	Hand-held breaker shall be fitted with mufflers. A movable enclosure made up of plywood is proposed to surround both worker and breaker during breaking process. The internal wall of the enclosure should be laid with sound absorbent such as mineral wool.	To lower noise transmission	DSD's Contractor	Whole construction site	Throughout construction phase	Construction phase	NCO, EIAO-TM
4.7	N10	Regular maintenance of plant equipment to prevent noise emission due to impair	To prevent noise emission due to impair	DSD's Contractor	Whole construction site	Throughout construction phase	Construction phase	NCO, EIAO-TM
4.7	N11	Position mobile noisy equipment in location and direction away from NSR	To minimize noise transmission to NSR	DSD's Contractor	Whole construction site	Throughout construction phase	Construction phase	NCO, EIAO-TM
4.7	N12	Use silencer or muffler on plant equipment and should be properly maintained	To minimize noise transmission	DSD's Contractor	Whole construction site	Throughout construction phase	Construction phase	NCO, EIAO-TM
4.7	N13	Throttle down or switch off unused machines or machine in intermittent use between work	To minimize noise production	DSD's Contractor	Whole construction site	Throughout construction phase	Construction phase	NCO, EIAO-TM
4.7	N14	Make good use of stockpiles or other structures for noise screening	To minimize noise transmission	DSD's Contractor	Whole construction site	Throughout construction phase	Construction phase	NCO, EIAO-TM
4.7	N15	Mobile plant should be sited as far away from NSRs as possible	To minimize noise transmission	DSD's Contractor	Whole construction site	Throughout construction phase	Construction phase	NCO, EIAO-TM
4.7	N16	Reduce the percentage on-time for some noisy PMEs	To minimize noise production	DSD's Contractor	Whole construction site	Throughout construction phase	Construction phase	NCO, EIAO-TM
4.7	N17	Carry out noise monitoring	To monitor construction noise level	DSD's Contractor	At representative NSRs	Prior to and throughout construction phase	Construction phase	EIAO-TM



**Annex A - Implementation Schedule of Recommended Mitigation Measures**

<b>EIA Ref.</b>	<b>EM&amp;A Ref.</b>	<b>Recommended Mitigation Measures *</b>	<b>Objectives of the Recommended Measure &amp; Main Concerns to address</b>	<b>Implementation Agent</b>	<b>Location of the measure</b>	<b>Duration of the measure</b>	<b>Implementation stages</b>	<b>Relveant Legislation &amp; Guidelines</b>
<b>Water Quality Impact</b>								
Project Specific Measures								
5.8	W1	Divert the water from outfall of W3 (stream near Fairway Vista) during open cut excavation for laying of gravity sewer nearby.	To prevent the excavated materials from falling into the water and being carried into the sea	DSD's Contractor	Whole construction site	Throughout construction phase	Construction phase	EIAO-TM
5.8	W2	Place sandbag along the upstream section of the stream near Fairway Vista and along rocky shore during open cut excavation for laying of gravity sewers/rising mains nearby.	To prevent the excavated materials from falling into the water and being carried into the sea	DSD's Contractor	Whole construction site	Throughout construction phase	Construction phase	ProPECC PN 1/94, EIAO-TM
5.8	W3	Intercept the water from u-channel at the foot of the slope where the STP will be built	To prevent water from entering the construction site	DSD's Contractor	Whole construction site	Throughout construction phase	Construction phase	ProPECC PN 1/94, EIAO-TM
6.8	W4	Install cofferdam around the proposed excavation area for entry pit of HDD work to prevent falling of debris into the sea	To prevent debris from entering the waterbodies	DSD's Contractor	HDD work site	Throughout construction phase	Construction phase	EIAO-TM
5.8	W5	Install sheet piles in marine waters by vibratory action.	To minimize dispersion of marine sediment	DSD's Contractor	Whole construction site	Throughout construction phase	Construction phase	EIAO-TM
5.8	W6	Marine works (dredging, construction and installation works at diffuser location, backfilling) shall be carried out inside the watertight cofferdam. The cofferdam can only be removed after completion of work.	To minimize dispersion of marine sediment	DSD's Contractor	Whole construction site	Throughout construction phase	Construction phase	EIAO-TM
5.8	W7	Dredging should be carried out by grab dredgers anchored outside the cofferdam. The marine sediment should be placed in sealed compartment of the marine barge.	To minimize dispersion of marine sediment	DSD's Contractor	Whole construction site	Throughout construction phase	Construction phase	EIAO-TM
5.8	W8	Water removed from the cofferdam should be desilted before discharge back into the sea.	To prevent discharge of silty water into the sea	DSD's Contractor	Whole construction site	Throughout construction phase	Construction phase	EIAO-TM
5.8	W9	Carry out water quality monitoring at water sensitive receivers before and during cofferdam installation works, throughout dredging works, and during cofferdam extraction works	To identify any water quality impact due to construction works	DSD's Contractor	Water Monitoirng Stations	Before and throughout installation and extraction works of cofferdam	Construction phase	EIAO-TM

Annex A - Implementation Schedule of Recommended Mitigation Measures

EIA Ref.	EM&A Ref.	Recommended Mitigation Measures *	Objectives of the Recommended Measure & Main Concerns to address	Implementation Agent	Location of the measure	Duration of the measure	Implementation stages	Relveant Legislation & Guidelines
5.8	W10	The following summarizes the precautionary measures for minimizing chance of emergency discharge: <ul style="list-style-type: none"> <li>• Provision of dual power by CLP;</li> <li>• Equipped with Supervisory control and data acquisition system (SCADA), which signals to the operation and maintenance personnel for emergency attendance in case of plant failure;</li> <li>• Provision of standby pump and screen at the PTOSTW.</li> <li>• Provision of emergency generator within 4 hours by DSD's future term contractor.</li> <li>• Provision of emergency storage with capacity of 4-hr sewage retention time.</li> <li>• Arrangement of tankers for removing incoming sewage to other sewage treatment plants for treatment.</li> </ul>	To prevent emergency discharge	DSD	Sewage Treatment Plant	Operational phase	Operational phase	EIAO-TM
5.8	W11	Carry out water quality monitoring at water sensitive receivers during normal operation	To identify any water quality impact due to the normal operation of the Sewage Treatment Plant (STP)	DSD	At representative WSRs	6 months before and in 1st year of operation	Operational phase	WPCO, EIAO-TM
<b>Generic/Standard Measures</b>								
5.8	W12	Set up sedimentation tank for settling suspended solids in wastewater before discharge into storm drains. Sand/silt removal facilities such as sand traps, silt traps and sedimentation basin should be provided with adequate capacity.	To reduce the amount of suspended solid in wastewater	DSD's Contractor	Whole construction site	Throughout construction phase	Construction phase	ProPECC PN 1/94, EIAO-TM
5.8	W13	Follow ProPECC PN 1/94 "Construction Site Drainage" as far as practicable	To minimize surface runoff and chance of erosion	DSD's Contractor	Whole construction site	Throughout construction phase	Construction phase	ProPECC PN 1/94, EIAO-TM
5.8	W14	Construct catchpits and perimeter channels prior to commencement of site formation works and earthworks.	To stop runoff from flowing across the construction site	DSD's Contractor	Whole construction site	Throughout construction phase	Construction phase	ProPECC PN 1/94, EIAO-TM
5.8	W15	Maintain silt removal facilities, channels, manholes before and after rainstorm.	To prevent failure that may lead to flooding	DSD's Contractor	Whole construction site	Throughout construction phase	Construction phase	ProPECC PN 1/94, EIAO-TM

**Annex A - Implementation Schedule of Recommended Mitigation Measures**

<b>EIA Ref.</b>	<b>EM&amp;A Ref.</b>	<b>Recommended Mitigation Measures *</b>	<b>Objectives of the Recommended Measure &amp; Main Concerns to address</b>	<b>Implementation Agent</b>	<b>Location of the measure</b>	<b>Duration of the measure</b>	<b>Implementation stages</b>	<b>Relveant Legislation &amp; Guidelines</b>
5.8	W16	Remove silt and grit from silt trap at regular interval.	To prevent blockage the may lead to flooding	DSD's Contractor	Whole construction site	Throughout construction phase	Construction phase	ProPECC PN 1/94, EIAO-TM
5.8	W17	Well design works program to minimize the work areas to minimize the soil exposure and site runoff.	To minimize surface runoff and chance of erosion	DSD's Contractor	Whole construction site	Throughout construction phase	Construction phase	ProPECC PN 1/94, EIAO-TM
5.8	W18	Arrange soil excavation works outside rainy seasons (April to September) as far as possible. If this cannot be achieved, the following measures should be implemented:	To minimize surface runoff and chance of erosion	DSD's Contractor	Whole construction site	Throughout construction phase	Construction phase	ProPECC PN 1/94, EIAO-TM
		- Cover temporary exposed slope surfaces with impermeable materials, e.g. tarpaulin						
		- Protect temporary access roads by crushed stone or gravel						
		- Provide intercepting channels along crest/edge of excavation						
		- Carry out adequate surface protection measures well before the arrival of a rainstorm						
5.8	W19	Minimize exposed earth after completion of work in a certain area by hydroseeding, vegetating, soil compacting or covering with bitumen	To prevent soil erosion under rainstorm	DSD's Contractor	Whole construction site	Throughout construction phase	Construction phase	ProPECC PN 1/94, EIAO-TM
5.8	W20	Prevent rainwater from entering trenches. Excavation of trenches should be dug and backfilled in short sections during rainy seasons. Remove silt in rainwater collected from the trenches or foundation excavations prior to discharge to storm drains.	To prevent soil erosion under rainstorm	DSD's Contractor	Whole construction site	Throughout construction phase	Construction phase	ProPECC PN 1/94, EIAO-TM
5.8	W21	Cover open stockpiles of construction materials (e.g. aggregates, sand and fill materials) with impermeable materials such as tarpaulin during rainstorms.	To prevent soil erosion under rainstorm	DSD's Contractor	Whole construction site	Throughout construction phase	Construction phase	ProPECC PN 1/94, EIAO-TM
5.8	W22	Cover and temporary seal manholes to prevent silt, construction materials or debris and surface runoff from entering foul sewers.	To prevent overloading of foul sewers	DSD's Contractor	Whole construction site	Throughout construction phase	Construction phase	ProPECC PN 1/94, EIAO-TM
5.8	W23	Remove waste from the construction site regularly.	To prevent waste accumulation	DSD's Contractor	Whole construction site	Throughout construction phase	Construction phase	ProPECC PN 1/94, EIAO-TM
5.8	W24	Apply discharge license for effluent discharge. Treat the discharge to comply with the requirement in TM-DSS.	To ensure compliance with effluent discharge requirement	DSD's Contractor	Whole construction site	Throughout construction phase	Construction phase	WPCO, TM-DSS, EIAO-TM

**Annex A - Implementation Schedule of Recommended Mitigation Measures**

<b>EIA Ref.</b>	<b>EM&amp;A Ref.</b>	<b>Recommended Mitigation Measures *</b>	<b>Objectives of the Recommended Measure &amp; Main Concerns to address</b>	<b>Implementation Agent</b>	<b>Location of the measure</b>	<b>Duration of the measure</b>	<b>Implementation stages</b>	<b>Relevant Legislation &amp; Guidelines</b>
5.8	W25	Reuse treated effluent onsite, e.g. dust suppression, wheel washing and general cleaning.	To minimize wastewater generation	DSD's Contractor	Whole construction site	Throughout construction phase	Construction phase	Waste Disposal Ordinance, EIAO-TM
5.8	W26	Monitor effluent water quality.	To ensure compliance with effluent discharge requirement	DSD's Contractor	Whole construction site	Throughout construction phase	Construction phase	WPCO, EIAO-TM
5.8	W27	Register as chemical waste producer if chemical waste will be generated.	To control chemical waste	DSD's Contractor	Whole construction site	Throughout construction phase	Construction phase	Waste Disposal (Chemical Waste) (General) Regulation, EIAO-TM
5.8	W28	Perform maintenance of vehicles and equipment that have oil leakage and spillage potential on hard standings within a bunded area with sumps and oil interceptors.	To prevent oil leakage or spillage	DSD's Contractor	Whole construction site	Throughout construction phase	Construction phase	Waste Disposal (Chemical Waste) (General) Regulation, EIAO-TM
5.8	W29	Dispose chemical waste in accordance to Waste Disposal Ordinance. Follow the <i>Code of Practice on the Packaging, Labelling and Storage of Chemical Wastes</i> , examples as follows: - Store chemical wastes with suitable containers to avoid leakage or spillage during storage, handling and transport - Label chemical waste containers according to the CoP to notify and warn the waste handlers - Store chemical wastes at designated safe location with adequate space	To avoid accident in waste storage and handling	DSD's Contractor	Whole construction site	Throughout construction phase	Construction phase	Waste Disposal Ordinance, EIAO-TM
5.8	W30	Provide sufficient chemical toilets with regular maintenance by registered waste collector where necessary	To proper collection of task force waste	DSD's Contractor	Whole construction site	Throughout construction phase	Construction phase	Waste Disposal Ordinance, EIAO-TM
5.8	W31	Provide a drip tray/container underneath the bentonite recycling system	To prevent any leaked bentonite from entering the watercourse or sea	DSD's Contractor	Whole construction site	Throughout construction phase	Construction phase	EIAO-TM
5.8	W32	Carry out regular site inspection to audit the implementation of mitigation measures	To check the implementation status and effectiveness of mitigation measures	DSD's Contractor	Water Monitoring Stations	Throughout construction phase	Construction phase	EIAO-TM, APCO
5.8	W33	Carry out effluent quality monitoring at location specified in the discharge licence	To ensure compliance with effluent discharge requirement	DSD	Effluent outlet	Operational phase	Operational phase	WPCO, EIAO-TM

Annex A - Implementation Schedule of Recommended Mitigation Measures

EIA Ref.	EM&A Ref.	Recommended Mitigation Measures *	Objectives of the Recommended Measure & Main Concerns to address	Implementation Agent	Location of the measure	Duration of the measure	Implementation stages	Relveant Legislation & Guidelines
<b>Terrestrial Ecology</b>								
Project Specific Measures								
6.12	E1	Erect bright colour fencing along the boundary of the undisturbed region of the shrubland and woodland, and around <i>Diospyros vaccinioides</i> , a plant species of conservation importance, near the work boundary to remind workers not to trespass or occupy the area, and to be careful during operation of equipment.	To protect the shrub from being damaged	DSD's Contractor	Whole construction site	Throughout construction phase	Construction phase	EIAO-TM
6.12	E2	Reinstate the disturbed rocky shore with the rocks temporarily removed	To restore the rocky shore habitat	DSD's Contractor	Whole construction site	After completion of works near the rocky shore	Construction phase	EIAO-TM
6.12	E3	Place sandbag around the section of W3 next to Fairway Vista and along the shore during open cut excavation for laying of gravity sewer nearby.	To prevent the excavated materials from falling into the water and being carried into the sea	DSD's Contractor	Watercourse W3	When construction work is carried out in the vicinity of W3	Construction phase	EIAO-TM
6.12	E4	Temporarily divert the water from outfall of W3 away from excavation area.	To prevent the excavated materials from falling into the water and being carried into the sea	DSD's Contractor	Watercourse W3	When construction work is carried out in the vicinity of W3	Construction phase	EIAO-TM
6.12	E5	Inspect the condition of the <i>Diospyros vaccinioides</i> near the work boundary as part of weekly site audit	To inspect the condition of the <i>Diospyros vaccinioides</i>	DSD's Contractor	The <i>Diospyros vaccinioides</i> near the work boundary	Throughout construction phase	Construction phase	EIAO-TM
Generic/Standard Measures								
6.12	E6	Erection of hoarding, fencing or provision of clear demarcation of work zones	To remind workers not to damage area outside the work boundary	DSD's Contractor	Whole construction site	Throughout construction phase	Construction phase	EIAO-TM
6.12	E7	Designate areas for placement of equipment, building materials and wastes away from the natural environment	To prevent damage on the natural environment	DSD's Contractor	Whole construction site	Throughout construction phase	Construction phase	EIAO-TM

Annex A - Implementation Schedule of Recommended Mitigation Measures

<b>EIA Ref.</b>	<b>EM&amp;A Ref.</b>	<b>Recommended Mitigation Measures *</b>	<b>Objectives of the Recommended Measure &amp; Main Concerns to address</b>	<b>Implementation Agent</b>	<b>Location of the measure</b>	<b>Duration of the measure</b>	<b>Implementation stages</b>	<b>Relveant Legislation &amp; Guidelines</b>
6.12	E8	Carry out tree preservation and compensatory tree planting will be carried out in accordance with DEVB TCW No. 7/2015.	To reinstated woodland habitat	DSD's Contractor	Whole construction site	After completion of works near woodland	Construction phase	EIAO-TM

Annex A - Implementation Schedule of Recommended Mitigation Measures

EIA Ref.	EM&A Ref.	Recommended Mitigation Measures *	Objectives of the Recommended Measure & Main Concerns to address	Implementation Agent	Location of the measure	Duration of the measure	Implementation stages	Relveant Legislation & Guidelines
<b>Waste Management</b>								
Project Specific Measures								
9.8	WM1	Sludge will be delivered by sealed sludge tanker for treatment at Sludge Treatment Facilities.	To prevent odour nuisance	DSD	STP	Throughout operational phase	Operational phase	Waste Disposal (Chemical Waste) (General) Regulation, EIAO-TM
9.8	WM2	Debris from screening process and general refuse should be stored within the STP in sealed container and be disposed of at landfill regularly.	To prevent odour nuisance	DSD	STP	Throughout operational phase	Operational phase	Waste Disposal (Chemical Waste) (General) Regulation, EIAO-TM
9.8	WM3	Worn filters and MBR membrane shall be stored and labelled as in construction phase. Chemical wastes shall be treated at chemical treatment facility by licensed contractor.	To prevent odour nuisance	DSD	STP	Throughout operational phase	Operational phase	Waste Disposal Ordinance, EIAO-TM
Generic/Standard Measures								
9.8	WM4	Allocate an area for waste sorting and storage of C&D materials into the following categories for reuse, recycle or disposal if possible. Remove waste from the construction site for sorting once generated if no suitable space can be identified. - excavated materials suitable for reuse - inert C&D materials (or public fill) for disposal offsite - non-inert C&D materials (or C&D waste) for disposal at landfills - chemical waste - bentonite slurry for reconditioning and reuse - general refuse	To minimize waste generation	DSD's Contractor	Whole construction site	Throughout construction phase	Construction phase	Waste Disposal Ordinance, EIAO-TM

**Annex A - Implementation Schedule of Recommended Mitigation Measures**

<b>EIA Ref.</b>	<b>EM&amp;A Ref.</b>	<b>Recommended Mitigation Measures *</b>	<b>Objectives of the Recommended Measure &amp; Main Concerns to address</b>	<b>Implementation Agent</b>	<b>Location of the measure</b>	<b>Duration of the measure</b>	<b>Implementation stages</b>	<b>Relveant Legislation &amp; Guidelines</b>
9.8	WM5	<p>Adopt good site practice as follows:</p> <ul style="list-style-type: none"> <li>- Provide training to workers on site cleanliness, waste management (waste reduction, reuse and recycle) and chemical handling procedures</li> <li>- Provide sufficient waste collection points and regular removal</li> <li>- Cover waste materials with tarpaulin or in enclosure during transportation</li> <li>- Maintain drainage systems, sumps and oil interceptors</li> <li>- Sort out chemical waste for proper handling and treatment onsite or offsite</li> </ul>	To proper handling of waste	DSD's Contractor	Whole construction site	Throughout construction phase	Construction phase	Waste Disposal Ordinance, EIAO-TM
9.8	WM6	<p>Adopt waste reduction measures as follows:</p> <ul style="list-style-type: none"> <li>- Allocate area/containers for sorting, recovering and storing waste for reuse, recycle or disposal (e.g. demolition debris and excavated materials, general refuse like aluminium cans.)</li> <li>Remove waste from the construction site for sorting once generated if no suitable space can be identified.</li> <li>- Allocate area for proper storage of construction materials to prevent contamination</li> <li>- Minimize wastage through careful planning and avoiding over-purchase of construction materials</li> </ul>	To minimize waste generation	DSD's Contractor	Whole construction site	Throughout construction phase	Construction phase	Waste Disposal Ordinance, EIAO-TM
9.8	WM7	Prepare and implement a site specific Waste Management Plan (WMP) as part of Environmental Management Plan (EMP) in accordance with ETWB TCW No. 19/2005. Detail waste management method in the form of avoidance, reuse, recovery, recycling, storage, collection, treatment and disposal according to the recommendations on the EIA and EM&A Manual. It should be approved by the ER and regularly reviewed.	To provide guidance to waste management	DSD's Contractor	Whole construction site	Throughout construction phase	Construction phase	ETWB TCW No. 19/2005, EIAO-TM



**Annex A - Implementation Schedule of Recommended Mitigation Measures**

<b>EIA Ref.</b>	<b>EM&amp;A Ref.</b>	<b>Recommended Mitigation Measures *</b>	<b>Objectives of the Recommended Measure &amp; Main Concerns to address</b>	<b>Implementation Agent</b>	<b>Location of the measure</b>	<b>Duration of the measure</b>	<b>Implementation stages</b>	<b>Relevant Legislation &amp; Guidelines</b>
9.8	WM8	Store waste materials properly as follows:	To properly store waste	DSD's Contractor	Whole construction site	Throughout construction phase	Construction phase	ProPECC PN 1/94, EIAO-TM
		- Avoid contamination by proper handling and storing waste						
		- Prevent erosion by covering waste						
		- Apply water spray on excavated materials						
		- Maintain and clean storage area regularly						
- Sort and stockpile different materials at designated location to enhance reuse								
9.8	WM9	Apply for relevant waste disposal permits in accordance with the Waste Disposal Ordinance (Cap. 354), Waste Disposal (Charges for Disposal of Construction Waste) Regulation (Cap. 345) and the Land (Miscellaneous Provisions) Ordinance (Cap. 28), Dumping at Sea Ordinance (Cap. 466).	To properly dispose waste	DSD's Contractor	Whole construction site	Throughout construction phase	Construction phase	Waste Disposal Ordinance (Cap. 354), Waste Disposal (Charges for Disposal of Construction Waste) Regulation (Cap. 345) and the Land (Miscellaneous Provisions) Ordinance (Cap. 28), Dumping at Sea Ordinance (Cap. 466), EIAO-TM
9.8	WM10	Hire licensed waste disposal contractors for waste collection and removal. Dispose waste at licensed waste disposal facilities	To properly dispose waste	DSD's Contractor	Whole construction site	Throughout construction phase	Construction phase	Waste Disposal Ordinance, EIAO-TM
9.8	WM11	Implement trip-ticket system for recording the amount of waste generated, recycled and disposed, including chemical wastes	To monitor movement of waste	DSD's Contractor	Whole construction site	Throughout construction phase	Construction phase	Waste Disposal (Chemical Waste) (General) Regulation, Waste Disposal Ordinance, EIAO-TM
9.8	WM12	Provide wheel washing at construction site exit to clean the vehicle body and wheel	To prevent dust from being brought offsite	DSD's Contractor	Whole construction site	Throughout construction phase	Construction phase	ProPECC PN 1/94, EIAO-TM
9.8	WM13	Reduce water content in wet spoil generated from piling work by mixing with dry materials. Only dispose treated spoil with less than 25% dry density to Public Fill Reception Facilities	To minimize load to reception facilities	DSD's Contractor	Whole construction site	Throughout construction phase	Construction phase	Waste Disposal Ordinance, EIAO-TM

**Annex A - Implementation Schedule of Recommended Mitigation Measures**

<b>EIA Ref.</b>	<b>EM&amp;A Ref.</b>	<b>Recommended Mitigation Measures *</b>	<b>Objectives of the Recommended Measure &amp; Main Concerns to address</b>	<b>Implementation Agent</b>	<b>Location of the measure</b>	<b>Duration of the measure</b>	<b>Implementation stages</b>	<b>Relevant Legislation &amp; Guidelines</b>
9.8	WM14	Dispose dry waste or waste with less than 70% water content by weight to landfill	To minimize load to reception facilities	DSD's Contractor	Whole construction site	Throughout construction phase	Construction phase	Waste Disposal Ordinance, EIAO-TM
9.8	WM15	Follow the <i>Code of Practice on the Packaging, Labelling and Storage of Chemical Waste</i> as follows:	To avoid accident in waste storage and handling	DSD's Contractor	Whole construction site	Throughout construction phase	Construction phase	Waste Disposal Ordinance, EIAO-TM
		- Store chemical wastes with suitable containers. Seal and maintain the container to avoid leakage or spillage during storage, handling and transport						
		- Label chemical waste containers in both English and Chinese with instructions in accordance to Schedule 2 of the Waste Disposal (Chemical Waste) (General) Regulation						
		- The container capacity should be smaller than 450 litres unless agreed by the EPD						
9.8	WM16	Comply with the requirement of the chemical storage area:	To ensure proper storage of chemical waste	DSD's Contractor	Whole construction site	Throughout construction phase	Construction phase	Waste Disposal Ordinance, EIAO-TM
		- Store only chemical waste and label clearly the chemical characters of the waste						
		- Have at least 3 sides enclosed and protected from rainfall with cover						
		- Provide sufficient ventilation						
		- Have impermeable floor and has bunds to contain 110% of the capacity of the largest container or 20% of the total volume of the stored waste in the area, whichever is larger						
		- Adequately spaced incompatible materials						
9.8	WM17	Transfer used lubricants, waste oils and other chemicals to oil recycling companies, if possible, and empty oil drums for reuse or refill. No direct or indirect discharge is permitted	To ensure proper disposal of chemical waste	DSD's Contractor	Whole construction site	Throughout construction phase	Construction phase	Waste Disposal (Chemical Waste) (General) Regulation, EIAO-TM
9.8	WM18	Hire licensed chemical waste disposal contractors for waste collection and removal. Dispose chemical waste at the approved Chemical Waste Treatment Centre at Tsing Yi or other licensed facility	To ensure proper disposal of chemical waste	DSD's Contractor	Whole construction site	Throughout construction phase	Construction phase	Waste Disposal (Chemical Waste) (General) Regulation, EIAO-TM
9.8	WM19	Hire reputable waste collector to separately collect and dispose general refuse from other wastes. Cover the waste to prevent being blown away	To ensure proper disposal of general refuse	DSD's Contractor	Whole construction site	Throughout construction phase	Construction phase	Waste Disposal (Chemical Waste) (General) Regulation, EIAO-TM

Annex A - Implementation Schedule of Recommended Mitigation Measures

<b>EIA Ref.</b>	<b>EM&amp;A Ref.</b>	<b>Recommended Mitigation Measures *</b>	<b>Objectives of the Recommended Measure &amp; Main Concerns to address</b>	<b>Implementation Agent</b>	<b>Location of the measure</b>	<b>Duration of the measure</b>	<b>Implementation stages</b>	<b>Relveant Legislation &amp; Guidelines</b>
9.8	WM20	Provide recycling bins for sorting out recyclables for collection by recycling companies. Non-recyclables should be removed to designated landfills every day by licensed collectors to prevent environmental and health nuisance.	To ensure proper recycling and disposal of general refuse	DSD's Contractor	Whole construction site	Throughout construction phase	Construction phase	Waste Disposal Ordinance, EIAO-TM
9.8	WM21	Organize training and reminders to site staff on waste minimization through avoidance and reduction, reusing and recycling	To ensure proper management of general refuse	DSD's Contractor	Whole construction site	Throughout construction phase	Construction phase	EIAO-TM
9.8	WM22	Used bentonite shall be reconditioned onsite and reused as far as practical to minimize wastage. If this is deemed not viable, the used bentonite shall be delivered offsite for reconditioning.	To minimize wastage of bentonite	DSD's Contractor	Whole construction site	Throughout construction phase	Construction phase	EIAO-TM
9.8	WM23	Characterize the sediment quality of the marine sediment to be dredged and submit a Sediment Quality Report for EPD's approval. Dispose the dredged marine sediment in accordance with ETWB TC(W) No. 34/2002	To verify the categories of sediment to be disposed in accordance with ETWB TC(W) No. 34/2002	DSD's Contractor	To be allocated by CEDD	Before dredging works	Construction phase	ETWB TC(W) No. 34/2002

Annex A - Implementation Schedule of Recommended Mitigation Measures

EIA Ref.	EM&A Ref.	Recommended Mitigation Measures *	Objectives of the Recommended Measure & Main Concerns to address	Implementation Agent	Location of the measure	Duration of the measure	Implementation stages	Relevant Legislation & Guidelines
<b>Landscape &amp; Visual</b>								
<b>Project Specific Measures</b>								
Table 10-6	CM8	Protective materials to be provided to natural rocky coastline to prevent damage to existing landform from plant and machinery during temporary drilling operations. Reinstatement following removal of plant & equipment to original or improved condition shall be undertaken.	To protect landscape resources	DSD's contractor	Temporary drilling site for submarine outfall	Construction planning and during construction period	Construction phase	Particular Specification
Table 10-7	OM1	Sensitive design of sewage treatment plant in terms of scale, height and bulk (visual weight) to integrate the building into the existing topography.	To mitigate visual impact	DSD's Design Architect/ Engineer	STP	Design Phase	Design Phase	Detailed Design Drawings and Specifications
Table 10-7	OM2	Use of appropriate building materials and colours for Sewage Treatment Plant to complement surroundings	To mitigate visual impacts	DSD's Design Architect/ Engineer	STP	Design Phase	Design, Construction and Operational Phases	Detailed Design Drawings and Specifications
				DSD's contractor		Construction Phase & first year in Operational Phase		
				Building Operator/DSD		Operational phase		
<b>Generic/Standard Measures</b>								
Table 10-6	CM1	The construction area and contractor's temporary works areas should be minimised to avoid impacts on adjacent landscape. All slope excavation shall take place from within the work boundary to minimise impacts on adjacent slopes.	To avoid impact on adjacent landscape areas	DSD's contractor	STP, along gravity sewers and rising mains construction route and at temporary drilling site for submarine outfall	Construction planning and during construction period	Construction phase	Detailed Design drawings and particular specifications
Table 10-6	CM2	Reduction of construction period to practical minimum	To minimise duration of impact	DSD's contractor	N/A	Construction planning and during construction period	Construction phase	N/A

Annex A - Implementation Schedule of Recommended Mitigation Measures

<b>EIA Ref.</b>	<b>EM&amp;A Ref.</b>	<b>Recommended Mitigation Measures *</b>	<b>Objectives of the Recommended Measure &amp; Main Concerns to address</b>	<b>Implementation Agent</b>	<b>Location of the measure</b>	<b>Duration of the measure</b>	<b>Implementation stages</b>	<b>Relevant Legislation &amp; Guidelines</b>
Table 10-6	CM3	Construction traffic (land and sea) including construction plant, construction vessels and barges to be kept to a practical minimum.	To minimize visual impacts to local residents and surrounding VSRs	DSD's contractor	STP, along gravity sewers and rising mains construction route at temporary drilling and dredging sites for submarine outfall	Construction planning and during construction period	Construction phase	As per the Particular Specification
Table 10-6	CM4	Erection of decorative mesh screens or construction hoardings and/or temporary noise barriers around works areas in visually unobtrusive colours.	To screen construction works from local residents and surrounding VSRs	DSD's contractor	STP, along gravity sewers and rising mains construction route and at temporary drilling site for submarine outfall	Construction planning and during construction period	Construction phase	As per the Particular Specification
Table 10-6	CM5	Avoidance of excessive height and bulk of site buildings and structures.	To reduce visual impact	DSD's contractor	STP, and at temporary drilling site for submarine outfall	Construction planning and during construction period	Construction phase	As per the Particular Specification
Table 10-6	CM6	Control of night-time lighting by hooding all lights and through minimisation of night working periods.	To maximize screening of the works	DSD's contractor	STP and at temporary drilling and dredging site for submarine outfall	Construction planning and during construction period	Construction phase	As per the Particular Specification

Annex A - Implementation Schedule of Recommended Mitigation Measures

<b>EIA Ref.</b>	<b>EM&amp;A Ref.</b>	<b>Recommended Mitigation Measures *</b>	<b>Objectives of the Recommended Measure &amp; Main Concerns to address</b>	<b>Implementation Agent</b>	<b>Location of the measure</b>	<b>Duration of the measure</b>	<b>Implementation stages</b>	<b>Relevant Legislation &amp; Guidelines</b>
Table 10-6	CM7	All existing trees shall be carefully protected during construction. A Detailed Tree Protection Specification shall be provided in the Contract Specification. Under this specification, the Contractor shall be required to submit, for approval, a detailed working method statement for the protection of trees prior to undertaking any works adjacent to all retained trees, including trees in contractor's works areas. Tree risk assessment shall be undertaken to all existing trees within the project site as per "Guidelines for Tree Risk Assessment and Management Arrangement"	To maximize protection of existing trees	DSD's contractor	STP and all other construction areas	Construction planning and during construction period	Construction phase	As per Tree Protection Particular Specification, DEVB TC (W) No.10/2013 and Guidelines for Tree Risk Assessment and Management Arrangement
Table 10-7	OM3	Lighting units to be directional and minimise unnecessary light spill and glare.	To mitigate visual impacts	DSD's Design Architect/ Engineer	STP	Design Phase	Design, Construction and Operational Phases	Detailed Design Drawings and Specifications
				DSD's contractor		Construction Phase & first year in Operational Phase		
				Building Operator/DSD		Operational phase		
Table 10-7	OM4	Greening measures to reinstate the landscape which are appropriate to the context, including tree and shrub planting and vertical greening, shall be implemented.	To mitigate visual impacts	DSD's Design Landscape Architect	STP	Design Phase	Design, Construction and Operational Phases	Detailed Design Drawings and Specifications
				DSD's contractor		Construction Phase & first year in Operational Phase		
				Building Operator/DSD		Operational phase		

Annex A - Implementation Schedule of Recommended Mitigation Measures

<b>EIA Ref.</b>	<b>EM&amp;A Ref.</b>	<b>Recommended Mitigation Measures *</b>	<b>Objectives of the Recommended Measure &amp; Main Concerns to address</b>	<b>Implementation Agent</b>	<b>Location of the measure</b>	<b>Duration of the measure</b>	<b>Implementation stages</b>	<b>Relveant Legislation &amp; Guidelines</b>
Table 10-7	OM5	Compensatory tree planting for all felled trees shall be provided to the satisfaction of relevant Government departments. Required numbers and locations of compensatory trees shall be determined and agreed separately with Government during the Tree Felling Application process under the relevant technical circulars. Tree risk assessment shall be undertaken to all existing trees within the project site as per “Guidelines for Tree Risk Assessment and Management Arrangement”	To mitigate landscape and visual impacts of tree loss	DSD's Landscape Architect	STP and at temporary drilling site for submarine outfall	Design Phase	Design, Construction and Operational Phases	As per approved Tree Removal Application, Detailed Design Drawings, Tree Protection Particular Specification and Guidelines for Tree Risk Assessment and Management Arrangement
				Contractor's Landscape Architect		Construction Phase & first year in Operational Phase		
				Building Operator/DSD		Operational phase		

Annex A - Implementation Schedule of Recommended Mitigation Measures

<b>EIA Ref.</b>	<b>EM&amp;A Ref.</b>	<b>Recommended Mitigation Measures *</b>	<b>Objectives of the Recommended Measure &amp; Main Concerns to address</b>	<b>Implementation Agent</b>	<b>Location of the measure</b>	<b>Duration of the measure</b>	<b>Implementation stages</b>	<b>Relevant Legislation &amp; Guidelines</b>
<b>Built Heritage</b>								
Project Specific Measures								
11.6	BH1	Undertake condition survey by professional qualified building surveyor or engineer to record the existing condition of the built heritage resources.	To record the condition of the built heritage resources before the commencement of construction works	DSD's Contractor	GB01, BH02, LF04	Before commencement of construction works	Construction phase	EIAO-TM and Guidelines for CHIA
11.6	BH2	Carry out vibration and settlement monitoring to built heritage resources. A maximum vibration level 7.5mm/s shall be adopted for the Grade 3 Hung Shing Temple and settlement check points in the Alert/Alarm/Action limit levels at 6mm/8mm/10mm shall be adopted.	To minimise the potential impact by mechanical vibration and settlement of built heritage resources	DSD's Contractor	GB01, BH02, LF04	During construction works	Construction phase	EIAO-TM and Guidelines for CHIA
11.6	BH3	Provision of protective covering or protective screen to built heritage resources which are close to the works area	To prevent direct impact from the machine and damages by construction tools or waste	DSD's Contractor	GB01, BH02, LF01, LF04	During construction works	Construction phase	EIAO-TM and Guidelines for CHIA
11.6	BH4	Maintain public access to the cultural landscape features as far as possible	To avoid the proposed works affecting the worshippers	DSD's Contractor	LF01, LF04, LF05	During construction works	Construction phase	EIAO-TM and Guidelines for CHIA
11.6	BH5	Provision of buffer zone of at least 1m from the proposed works as far as possible	To prevent any direct and indirect impact	DSD's Contractor	BH02, LF01, LF04	During construction works	Construction phase	EIAO-TM and Guidelines for CHIA

\* All recommendations and requirements resulted during the course of EIA Process, including ACE and/or accepted public comment to the proposed project



***Appendix 6-3***

---

*Recommended Mitigation Measures and Proactive Environmental Protection  
Proforma*

**Appendix 6-3 Recommended Mitigation Measures and Proactive Environmental Protection Proforma**

Reporting Period: 2022-05-01 – 2022-05-31

Construction Works Area: PTO-SW-03, PTO-Trenchless -01&amp; STP

Anticipated Impacts: Dust, Noise, Water Quality, Terrestrial Ecology, Marine Ecology, Fisheries, Waste Management, Landscape and Visual and Build Heritage Impact.

Item	EIA Ref.	EM&A Ref.	Environmental Aspect	Corresponding Mitigation Measures	EM&A Manual Recommended Mitigation/ Actions	Action By	Measurement Procedures/Methods
Air Quality Impact	3.8	A10 - A25	<p>a) Major air quality impact in construction phase would arise from excavation of slope at the proposed sewage treatment plant.</p> <p>b) Excavation, Gas welding, slope cutting, Rock dowel, fencing, flexible barrier installation Loading &amp; Unloading Dusty Materials storage, Dusty Waste Sorting, Temporary Site Traffic Control</p>	<p>a) All construction plants / machineries will be checked / serviced on a regular basis during the courses of construction to minimize the emission of noise generation and eliminate dark smoke emission</p> <p>b) All dump trucks will be equipped with mechanical covers to prevent the dust emission during transportation when necessary.</p> <p>c) Dust control measures, such as water spraying, will be provided during</p>	<p>(a) Hoarding of not less than 2.4 m high shall be erected from ground level to surround the work area along Po Toi O Chuen Road except for a site entrance or exit.</p> <p>(b) Good housekeeping to minimize dust generation, e.g. by properly handling and storing dusty materials.</p> <p>(c) Adopt dust control measures, such as dust suppression using water spray on exposed soil at least 4 times a day, in areas with dusty construction activities and during material handling.</p> <p>(d) Minimize exposed earth after completion of work in a</p>	Contractor	<p>a) 1-hour and 24-hour TSP levels will be measured in accordance to the standard high-volume sampling method as set out in the Title 40 of the Code of Federal Regulations, Chapter 1 (Part 50), Appendix A.</p> <p>b) Due to objection from the residents of Po Toi O village of the use of high-volume sampler (HVS) in conducting 24-hours TSP measurement, 24-hour TSP measures for impact monitoring is to be measured by portable dust meters during construction phase of the project. This is to be approved and verified by ER and IEC.</p>

Item	EIA Ref.	EM&A Ref.	Environmental Aspect	Corresponding Mitigation Measures	EM&A Manual Recommended Mitigation/ Actions	Action By	Measurement Procedures/Methods
				<p>demolition works when necessary.</p> <p>d) Maintaining of wet surface on access road and keep slow speed in the site.</p> <p>e) Conditions in the Environmental Permit and Discharge License should be followed</p> <p>f) Predict required quantity of concrete accurately and collect the unused fresh concrete at designated locations in the site for subsequent disposal.</p> <p>g) Provide sufficient mitigation measures as recommended in approved EIA Manual requirement.</p>	<p>certain area by hydroseeding, vegetating, soil compacting or covering with bitumen.</p> <p>(e) Provide wheel washing at site exit to prevent carrying dust outside of the site.</p> <p>(f) Cover materials on trucks before leaving the site.</p> <p>(g) Limit vehicle speed of construction trucks within the construction site and in Po Toi O, maximum at 10km/hr, and confine vehicle movement in haul road.</p> <p>(h) As there is limited space in Po Toi O, stockpiling should be avoided. However, if found necessary, the materials should be covered by impervious materials such as tarpaulin.</p>		<p>c) Other than using high volume sampler, 1-hour TSP levels can be measured alternatively by direct reading from portable dust meters upon approval from ER. The meters should be capable of producing comparable results as that by the high-volume sampling method, to indicate short event impacts.</p> <p>d) -The ET shall agree with the IEC on the monitoring position and the corrections adopted.</p> <p>e) -The agreed position shall be chosen in subsequent baseline and impact monitoring.</p>

Item	EIA Ref.	EM&A Ref.	Environmental Aspect	Corresponding Mitigation Measures	EM&A Manual Recommended Mitigation/ Actions	Action By	Measurement Procedures/Methods
Noise Impact Control	4.7	N1 - N17	<p>a) The Project comprises three main works including the construction of sewage treatment plant (STP), underground sewers and rising main, and the submarine outfall</p> <p>b) The major noise impact will arise from the use of powered mechanical equipment.</p> <p>c) Excavation, Gas welding, slope cutting, Rock dowel, fencing, flexible barrier installation Loading &amp; Unloading Dusty Materials storage, Temporary Site Traffic Control</p>	<p>a) Conditions in the Environmental Permit and Discharge License should be followed</p> <p>b) Provide sufficient mitigation measures as recommended in approved EIA Manual requirement.</p>		Contractor	<p>a) Noise measurement shall normally be at a point 1 m from the exterior of the sensitive receiver building façade and be at a position 1.2 m above the ground. If the normal monitoring position cannot be accessed, an alternative position may be chosen, and a correction to the measurements shall be made. For reference, a correction of +3 dB(A) shall be made to the free field measurements.</p> <p>b) The ET shall agree with the IEC on the monitoring position and the corrections adopted.</p> <p>c) The agreed position shall be chosen in subsequent baseline and impact monitoring.</p>

Item	EIA Ref.	EM&A Ref.	Environmental Aspect	Corresponding Mitigation Measures	EM&A Manual Recommended Mitigation/ Actions	Action By	Measurement Procedures/Methods
Water Quality impact	5.8	W1 - W33	a) Major Water quality impact will be originated from minor displacement of suspended solids during installation, testing pipe and extraction of cofferdam around the proposed diffuser.	<p>a) Wastewater to be treated by wastewater treatment facilities before discharge</p> <p>b) Conditions in the Environmental Permit and Discharge License should be followed</p>	<p>(a) Well manage construction materials, chemicals, sewage for proper storage and usage and to prevent accumulation onsite.</p> <p>(b) Immediately clean up contaminated soil upon chemical and oil leakage.</p> <p>(c) Label chemical waste containers according to the Code of Practice to notify and warn the waste handlers. Store fuels, chemicals and chemical waste at designated area with locks and bunds.</p> <p>(d) Register as chemical waste producer.</p> <p>(e) Set up sedimentation tank for settling suspended solids in wastewater before discharge into storm</p>	Contractor	<p>a) Weekly site audit to monitor the implementation of the proposed water quality mitigation measures and check the Contractor's work practice on water pollution prevention during construction phase.</p> <p>b) Should water pollution is observed (e.g. discharge of silty water into storm drains), the ET should record the environmental deficiency for investigation.</p> <p>c) The Contractor should be notified and responsible for carrying out rectification work immediately.</p> <p>d) The ET shall re-inspect the Project Site and review the effectiveness of the remedial measure performed until satisfaction.</p> <p>e) The Contractor shall implement preventive</p>

Item	EIA Ref.	EM&A Ref.	Environmental Aspect	Corresponding Mitigation Measures	EM&A Manual Recommended Mitigation/ Actions	Action By	Measurement Procedures/Methods
					<p>drains. Sand/silt removal facilities such as sand traps, silt traps and sedimentation basin should be provided with adequate capacity.</p> <p>(f) Provide sufficient number of chemical toilets if necessary and employ licensed contractor for regular clean-up and maintenance.</p> <p>(g) Provide wheel washing at site exit to prevent dust and silty water from leaving the construction site.</p> <p>(h) Cover slope and loose materials with tarpaulin before rainstorm and inspect the area afterwards.</p> <p>(i) Cover manhole to prevent silt, construction materials or debris and surface runoff from entering the foul sewer.</p>		<p>measure to avoid causing the same problem.</p>

Item	EIA Ref.	EM&A Ref.	Environmental Aspect	Corresponding Mitigation Measures	EM&A Manual Recommended Mitigation/ Actions	Action By	Measurement Procedures/Methods
					(j) Install fully enclosed cofferdam around the proposed diffuser and deploy a dredger barge outside the cofferdam for dredging and filling works.		

Item	EIA Ref.	EM&A Ref.	Environmental Aspect	Corresponding Mitigation Measures	EM&A Manual Recommended Mitigation/ Actions	Action By	Measurement Procedures/Methods
Terrestrial Ecology	6.12	E1-E8	<p>a) The proposed Project will cause minor habitat loss of shrubland, temporary habitat loss of woodland, developed area and rocky shore, and removal of one individual climber species of conservation importance that is common within the Study Area and Hong Kong. Indirect water quality impact may arise from surface runoff or accidental spillage of chemicals in construction phase.</p> <p>b) Use of powered plant equipment may bring noise disturbance on wildlife.</p>	<p>a) Conditions in the Environmental Permit and Discharge License should be followed</p> <p>b) Provide sufficient mitigation measures as recommended in approved EIA Manual requirement.</p>	<p>a) Construction noise and water quality mitigation measures proposed in the previous sections will be applicable to terrestrial ecology.</p>	Contractor	<p>(a) Bright colour fencing shall be erected along the boundary of the undisturbed region of the shrubland and woodland, and around <i>Diospyros vaccinioides</i>, a plant species of conservation importance, near the work boundary to remind workers not to trespass or occupy the area, and to be careful during operation of equipment.</p> <p>(b) Inspect the condition of <i>Diospyros vaccinioides</i> as part of weekly site audit.</p> <p>(c) Reinstatement of the disturbed rocky shore with the rocks temporarily removed.</p> <p>(d) Carry out compensatory tree planting in accordance with DEVB TCW No. 7/2015 to reinstate the affected woodland.</p>



Item	EIA Ref.	EM&A Ref.	Environmental Aspect	Corresponding Mitigation Measures	EM&A Manual Recommended Mitigation/ Actions	Action By	Measurement Procedures/Methods
Marine Ecology	7	7	<p>a) The proposed Project will cause minor habitat loss of muddy seabed.</p> <p>b) Indirect water quality impact may arise from installation and extraction of sheet pile of cofferdam in construction phase.</p> <p>c) Dredging and backfilling for installation of diffuser will be conducted inside fully enclosed cofferdam. No marine sediment loss to water column is expected.</p>	a) Conditions in the Environmental Permit and Discharge License should be followed	a) The variation in water quality at coral and amphioxus habitats during cofferdam installation and extraction works will be overseen by water quality monitoring mentioned.	Contractor	a) No specific monitoring and audit programme is required. With proper implementation of water quality mitigation measures, residual impact is expected to be acceptable.

Item	EIA Ref.	EM&A Ref.	Environmental Aspect	Corresponding Mitigation Measures	EM&A Manual Recommended Mitigation/ Actions	Action By	Measurement Procedures/Methods
Fisheries	8	8	<p>a) No direct encroachment on Fish Culture Zone and Artificial Reefs in the Study Area is expected.</p> <p>b) About 1,920 m<sup>2</sup> of fishing ground and 500 m<sup>2</sup> of benthic spawning ground will be affected. Except the 5 m<sup>2</sup> benthic spawning ground will be lost permanently, other impacted area will only be affected in construction phase temporarily (reversible impact). Indirect impact on fisheries resources by the water quality deterioration will be insignificant with proper implementation of water quality mitigation measures.</p>	a) Conditions in the Environmental Permit and Discharge License should be followed	Water quality at FCZ will be monitored during cofferdam installation and extraction works and dredging works in the construction phase as proposed.	Contractor	a) No specific monitoring and audit programme are required. With proper implementation of water quality mitigation measures, residual impact is anticipated to be acceptable.

Item	EIA Ref.	EM&A Ref.	Environmental Aspect	Corresponding Mitigation Measures	EM&A Manual Recommended Mitigation/ Actions	Action By	Measurement Procedures/Methods
Waste Management	9.8	WM4-WM23	<p>a) Construction of the sewage treatment plant, laying of gravity sewers and rising mains and submarine outfall are expected to generate mainly inert construction and demolition (C&amp;D) materials (or public fill) from excavation, and unused building materials. Other wastes include non-inert C&amp;D materials (or C&amp;D waste), plant materials, scaffolding, formwork and packaging, chemical waste from plant maintenance, bentonite slurry from drilling works and general refuse from workers.</p> <p>b) Dredging at the proposed diffuser location will generate marine sediment.</p>	<p>a) All C&amp;D materials generated will be transported and stored at temporary storage area. Cover will be provided during transportation of dusty materials. Suitable materials will be sorted for reuse on-site. Only non-inert C&amp;D material will be disposed off-site to NENT Landfill.</p> <p>b) Conditions in the Environmental Permit and Discharge</p>	<p>(a) Reuse C&amp;D materials onsite and dispose excess uncontaminated ones to public fill.</p> <p>(b) Provide sufficient waste collection points for general refuse and regularly maintained to avoid accumulation. Dispose the waste at waste transfer or disposal facilities.</p> <p>(c) Minimize wastage through careful planning and avoiding over-purchase of construction materials.</p> <p>(d) Provide training to workers on site cleanliness, waste management (waste reduction, reuse and recycle) and chemical handling procedures.</p> <p>(e) Hire licensed waste disposal contractors for</p>	Contractor	<p>The Contractor should apply for relevant licences/permits for waste disposal under different regulations and ordinances as follows:</p> <p>(a) Chemical Waste Permits/licenses under the Waste Disposal Ordinance (Cap 354);</p> <p>(b) Public Dumping Licence under the Land (Miscellaneous Provisions) Ordinance (Cap 28);</p> <p>(c) Marine Dumping Permit under Dumping at Sea Ordinance (Cap 466); and</p> <p>(d) Effluent Discharge Licence under the Water Pollution Control Ordinance (Cap 358).</p> <p>b) Reference should be made to EPD's booklets on licences/permits. The Contractor shall also document recycling receipts/ disposal record to keep track of waste movement. The ET shall check with the Contractor</p>

Item	EIA Ref.	EM&A Ref.	Environmental Aspect	Corresponding Mitigation Measures	EM&A Manual Recommended Mitigation/ Actions	Action By	Measurement Procedures/Methods
				<p>License should be followed</p> <p>c) Fueling of equipment will be conducted carefully on-site by mobile tanker to avoid storage of fuel and oil spillage.</p> <p>d) Provision of drip trays for equipment likely cause spillage of chemical / fuel, and provide routine maintenance.</p>	<p>waste collection and removal. Dispose waste at licensed waste disposal facilities.</p> <p>(f) Recondition and reuse bentonite as far as practical.</p> <p>(g) Conduct marine sediment test and dump dredged marine sediment according to <i>ETWB TCW No. 34/2002 Management of Dredged/Excavated Sediment and Dumping at Sea Ordinance.</i></p> <p>(h) Chemical waste shall be handled, stored and disposed properly, according to the relevant guidelines.</p>		<p>that these licences/permits have been obtained. He should also review the above documentations regularly to ensure compliance with legislations and specifications.</p>

Item	EIA Ref.	EM&A Ref.	Environmental Aspect	Corresponding Mitigation Measures	EM&A Manual Recommended Mitigation/ Actions	Action By	Measurement Procedures/Methods
Landscape and Visual impact	Table 10-6 & 10-7	CM1-CM8 & OM1-OM5	a) Minor landscape and visual impact is expected due to dredging work in open sea, construction of the STP and pipelines on land and the loss of existing trees and vegetation at the sewage treatment plant site in the construction phase.	a) Conditions in the Environmental Permit and Discharge License should be followed  b) Implement the recommended mitigation proposed in EM&A manual	a) The contractor shall employ a professionally qualified Registered Landscape Architect (RLA) on the Environmental Team to supervise and monitor the implementation of construction phase landscape and visual mitigation measures. This is necessary to ensure that all the recommended landscape and visual mitigation measures under Chapter 10 of the EIA are effectively implemented including minimization of the works footprint, ensuring that those existing trees earmarked for retention on site or transplanting are protected and planting works are correctly implemented.	Contractor	a) Tree risk assessment shall be undertaken by the contractor during construction to all existing trees within the project site as per "Guidelines for Tree Risk Assessment and Management Arrangement".  b) Site inspections by appointed RLA shall be undertaken at monthly intervals to closely monitor all these aspects of work. Inspection findings shall be logged in a site monitoring report with any discrepancies or concerns regarding the implementation and effectiveness of mitigation measures highlighted.

Item	EIA Ref.	EM&A Ref.	Environmental Aspect	Corresponding Mitigation Measures	EM&A Manual Recommended Mitigation/ Actions	Action By	Measurement Procedures/Methods
Build Heritage	11.6	BH1 - BH5	a) As the proposed work is close to some of the identified built heritage resources, condition survey, vibration and settlement monitoring are recommended to identified built heritage to prevent indirect damage by mechanical vibration and settlement.	a) Conditions in the Environmental Permit and Discharge License should be followed b) Provide sufficient mitigation measures as recommended in approved EIA Manual requirement.	a) Provision of protective covering or protective screen is recommended to identified built heritage to prevent damages by construction tools or waste. b) Maintenance of public access is suggested for identified built heritage. Besides, buffer zone of at least 1m from the works boundary should be provided for identified built heritage as far as possible. c) Condition survey, vibration and settlement monitoring to identified built heritage.	Contractor	a) A maximum vibration level of 7.5mm/s shall be adopted for the Grade 3 Hung Shing Temple and settlement check points in the Alert/Alarm/Action limit levels at 6mm/8mm/10mm shall be adopted.

***Appendix 6-4***

---

*Cumulative Statistics on Complaints, Notifications of Summons*

**Appendix 6-4 Cumulative Statistics on Complaints, Notifications of Summons, Successful Prosecutions and Public Engagement Activities****Environmental Complaints Log**

Complaint Log No.	Date of Complaint	Received From	Received By	Nature of Environmental Complaint	Relevant to the Construction Work of Project Site? (Y/N)	Investigation/ Mitigation Action	Status
001	28 December 2021	EPD	ET	Waste Management	N	The investigation report was submitted on 7 January 2022	Closed

*Remark:*

*\* No complaints, Notifications of Summons, or Successful Prosecutions were received in the reporting period.*

**Cumulative Statistics on Complaints, Notifications of Summons and Successful Prosecutions and Public Engagement Activities**

Reporting Period	Complaints	Notifications of Summons and Prosecutions	Public Engagement Activities
<b>This Month</b>	0	0	0
<b>Cumulative Project-to-Date</b>	1	0	0